

INTRODUCTION



TABLE OF CONTENTS

- 0 INTRODUCTION..... 2**
- 0.1 WHAT IS THE *FIRST* ROBOTICS COMPETITION?..... 2
- 0.2 GRACIOUS PROFESSIONALISM, A *FIRST* CREDO..... 2
- 0.3 SAFETY, A *FIRST* CULTURE 3
- 0.4 THE 2007 GAME – “*RACK 'N' ROLL*” 3

0 INTRODUCTION

0.1 WHAT IS THE *FIRST* ROBOTICS COMPETITION?

The *FIRST* Robotics Competition is an exciting program that assimilates teams, sponsors, colleges, and technical professionals with high school students to develop their solution to a prescribed engineering challenge in a competitive game environment. The program has resulted in life-changing, career-molding experiences for its participants. It is also a lot of fun.

In 2007, our reach will expand to over 33,000 students representing approximately 1300 teams. These teams will come from every state in the U.S., as well as from Brazil, Canada, the United Kingdom, Mexico, Israel, and the Netherlands. *FIRST* has truly become an international program and is continuously growing. These teams will participate in 37 Regional Competitions and can qualify for the Championship Event at The Georgia Dome in Atlanta, Georgia. The competitions combine the practical application of science and technology with the fun, intense energy, and excitement of a championship-sporting event.

This year's challenge will be presented at the 2007 *FIRST* Robotics Competition Kickoff on Saturday, January 6, 2007. At the Kickoff, all teams:

- Will see this year's game and field for the first time
- Will learn about the 2007 game rules and regulations
- Will receive a kit of parts. The Kit of Parts will include motors, sensors, chassis, transmissions, vision camera, bearings, and other materials that teams can use in the design and construction of their robots. They will also receive a multi-channel radio control system and a 12V battery power supply. The kit is meant to provide a level starting point for all teams. The rules also describe the additional items teams can purchase.

When you bring dedicated, enthusiastic students, teachers, engineers, and other professionals together, they will produce a wide range of amazing machines that are competition ready in six weeks of construction time.

0.2 GRACIOUS PROFESSIONALISM, A *FIRST* CREDO

Dr. Woodie Flowers, *FIRST* National Advisor, asks and provides his view regarding the question, "Why do *FIRST* folks talk so much about that phrase?"

Quoting Dr. Flowers, "Obviously it would not make sense to endorse 'asinine professionalism' or 'gracious incompetence'. It is, however, completely consistent with the *FIRST* spirit to encourage doing high quality, well-informed work in a manner that leaves everyone feeling valued. Gracious professionalism seems to be a good descriptor for part of the ethos of *FIRST*. It is part of what makes *FIRST* different and wonderful.

Gracious professionalism has purposefully been left somewhat undefined because it can and should mean different things to each of us. We can, however, outline some of its possible meanings. Gracious attitudes and behaviors are win-win. Gracious folks respect others and let that respect show in their actions. Professionals possess special knowledge and are trusted by society to use that knowledge responsibly. Thus, gracious professionals make a valued contribution in a manner pleasing to others and to themselves.

In *FIRST*, one of the most straightforward interpretations of gracious professionalism is that we learn and compete like crazy, but treat one another with respect and kindness in the process. We

try to avoid leaving anyone feeling like they are losers. No chest thumping barbarian tough talk, but no sticky sweet platitudes either. Knowledge, pride, and empathy comfortably blended.

Understanding that gracious professionalism works is not rocket science. It is, however, missing in too many activities. At FIRST, it is alive and well. Please help us take care of it.

In the long run, gracious professionalism is part of pursuing a meaningful life. If one becomes a professional, and uses knowledge in a gracious manner, everyone wins. One can add to society and enjoy the satisfaction of knowing that you have acted with integrity and sensitivity. That's good stuff!"

0.3 SAFETY, A *FIRST* CULTURE

Safety is an important part of *FIRST* culture and should be observed by all participants at all times. As a part of Safety Awareness and Recognition Program, teams will be observed and evaluated at many different levels and by many individuals at the event. Safety Advisors will evaluate team safety behavior and practices in the Pit from the time the robot is uncrated, until the robot is re-created for shipment. Referees will observe safety on the playing field as well as adherence to the rules. Judges will evaluate how teams have integrated safety into their robot designs when considering the team for technical awards.

0.4 THE 2007 GAME – “RACK ‘N’ ROLL”

Rack ‘n’ Roll is played by two (2) three-team alliances on a 54’x26’ 8” field with a center structure (Rack) containing 24 “spider legs.” To score, teams use three different types of tubes called “Keepers,” “Ringers,” and “Spoilers.”

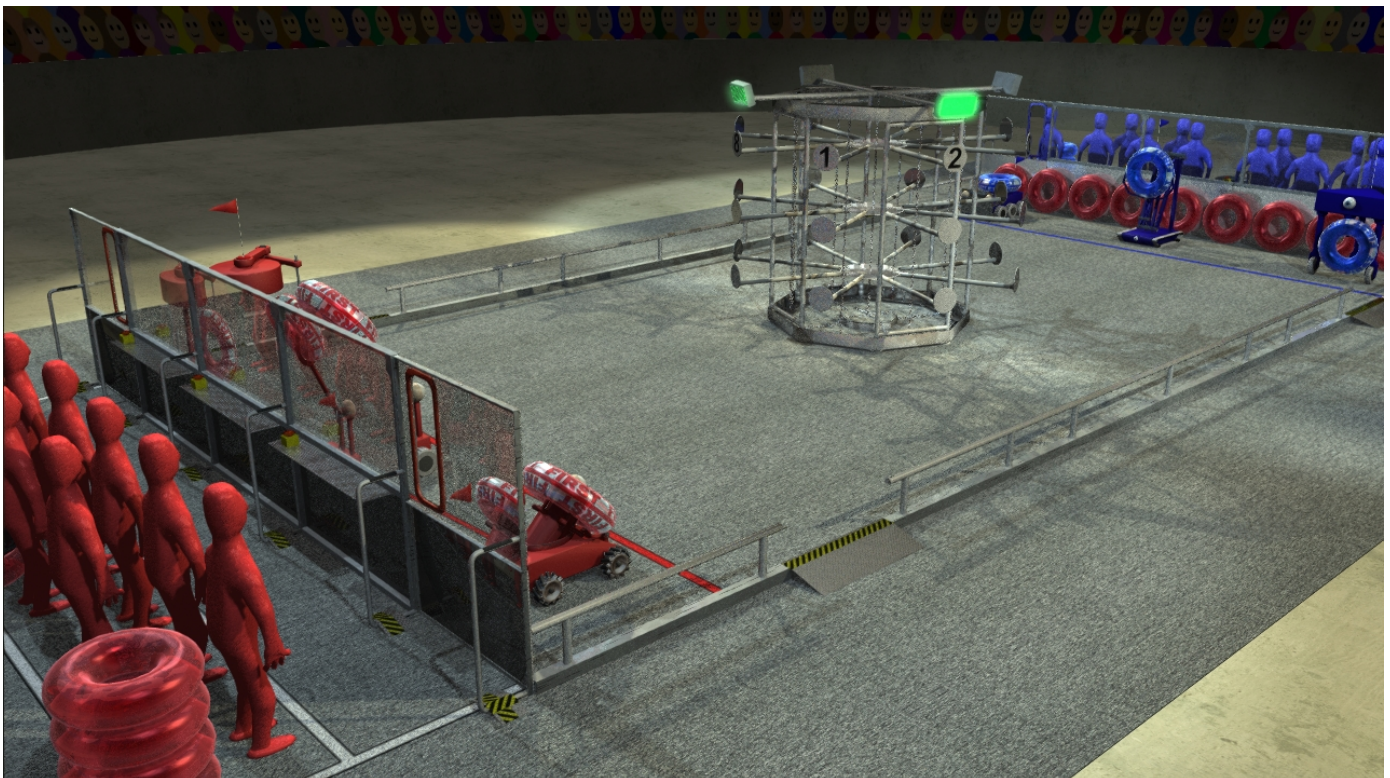

The game is made up of two scoring periods. The first period is “Autonomous” (the robots run without driver control) lasting 15 seconds. In the autonomous period, robots try to place a “Keeper” tube on one of the spider legs of the Rack using a color vision tracking system to find one of the

four target lights at the top of the rack. Once placed, a “Keeper” tube may not be removed or “Spoiled.”

During the second period (2 minutes), the robots are driver controlled. In this period the teams will attempt to score more points by using the robots to add “Ringers” onto the spider legs or by “Spoiling” the opposing teams score by placing a black tube over the “Ringer.” Points are earned and scored exponentially by the number of consecutive Ringers and Keepers in a column or row.

Alliances may score additional points if, by the end of the match, their robots are in their home zone and have been lifted off the floor by 4” or more by another robot before the final buzzer sounds.

Explanation of Game Pieces:

Red or Blue w/lettering	Red or Blue w/out lettering	Black
Keeper	Ringer	Spoiler

Robot Height/Weight

Class	I	II	III
Height	48”	60”	72”
Weight	120 lbs.	110 lbs.	100 lbs.

Scoring Table

Game Pieces	Singleton	2	3	4	5	6	7	8
Point Value	2	4	8	16	32	64	128	256

Robots off the ground

>= (greater than or equal to) 4”, less than 12”	15 points
12” or higher	30 points

COMMUNICATION



TABLE OF CONTENTS

1 COMMUNICATION	2
1.1 OVERVIEW	2
1.2 <i>FIRST</i> HEADQUARTERS- CONTACT INFORMATION	2
1.3 TEAM SUPPORT	2
1.3.1 Emails and Subject Lines	2
1.3.2 Please Do Not Duplicate Efforts	2
1.4 INNOVATION FIRST, INC.....	2
1.5 THE <i>FIRST</i> STORE (PARTS)	3
1.6 <i>FIRST</i> ROBOTICS COMPETITION WEBSITE	3
1.6.1 Getting Answers To Your Competition Questions	3
1.6.2 Team Website Links	3
1.6.3 NEW: Archived Team Email Blasts	3
1.6.4 Team Updates	4
1.6.5 Recruitment & Public Relations Materials.....	4
1.7 THE TIMS - SUPPLYING INFORMATION TO <i>FIRST</i>	4
1.7.1 TIMS Access for Both Main and Alternate Contacts.....	4
1.7.2 International Teams	5
1.7.3 "Off Season" and Current Contact Information.....	5
1.7.4 Mentoring & Team Organization.....	5
1.7.5 Team Names –Official, Short, and Nickname Deadlines.....	5
1.7.6 Judges' Yearbook Page.....	5
1.8 AUTODESK CONTACT INFORMATION	7
1.9 EVENT-SPECIFIC INFORMATION.....	7
1.10 NEW: REGIONAL EVENTS HOTEL SEARCH INFORMATION	7
1.11 CHAMPIONSHIP HOTEL INFORMATION.....	8
1.12 <i>FIRST</i> LOGOS	8
1.12.1 Logo Use	8
1.12.2 Finding This Year's Competition Logo.....	9
1.13 PROVIDING CORPORATE SPONSORSHIP	9
1.14 HOW TO VOLUNTEER FOR <i>FIRST</i>	9

1 COMMUNICATION

1.1 OVERVIEW

This section provides teams with necessary information for contacting *FIRST* staff, Innovation First, and Autodesk. This section also contains help regarding the use of the *FIRST* logo, finding materials on the website, updating the Team Information Management System (TIMS), tips on reserving hotels, and other informational topics such as the Yearbook Page.

1.2 *FIRST* HEADQUARTERS- CONTACT INFORMATION

You can reach *FIRST* via mail, phone, and fax, or get information from our website at <http://www.usfirst.org/>. The office is open Monday through Friday from 8:30 a.m. to 5:00 p.m., EST. Refer to the sections below for the appropriate help resource. *Be sure to provide your team number on all communications.*

Mailing Address:	Phone Numbers:	Fax Numbers:	
<i>FIRST</i> 200 Bedford Street Manchester, NH 03101	(603) 666-3906 or (800) 871-8326	Main Engineering Finance	(603) 666-3907 (603) 666-0043 (603) 647-5772

1.3 TEAM SUPPORT

The Operations, Team Support Group is ready answer program-related questions regarding registration and team record maintenance, the Kickoff, and the shipping and drayage process. We are ready to help your team. If you leave a voice mail, make it short but detailed and include your team number, name, email address, and phone number. A representative will research the question and return your call or answer via email.

Email Address: frcteams@usfirst.org

Phone: (603) 666-3906 or (800) 871-8326 – **Press 0 for Operations Team Support / Operator.**

1.3.1 Emails and Subject Lines

Our program requires that many requests must be in writing, so email may be your best communication tool and the best way to get a quick answer or solution to your problem. Emails save money, time, prevent phone tag, and provide information for a researched, more accurate answer. To facilitate a quick reply, include your team number and reference in the subject line.

1.3.2 Please Do Not Duplicate Efforts

We ask that you do not contact or copy multiple persons about the same problem. Being a small group, we must work efficiently and avoid having more than one person working on the same item. We can usually answer questions or requests within one working day.

1.4 INNOVATION FIRST, INC.

(Control System-Speed Controllers)

Contact Innovation First, Inc. for help with items such as: Operator Interface, Robot Controller, Radios, Speed Controllers, and Relay Modules. Remember to provide your *FIRST* team number in the subject line.

Tech Support Phone: (903) 453-0802

Tech Support Email Address: info@IFIRobotics.com

Website: WWW.IFIRobotics.com

1.5 THE *FIRST* STORE (PARTS)

After Kickoff, Innovation First Inc. (IFI) will host an on-line store on behalf of *FIRST* so teams can purchase listed Kit of Parts items. IFI will have the *FIRST* Store located on its website (www.ifirobotics.com). Only *FIRST* teams will be authorized to purchase these parts. *FIRST* will establish pricing for all parts, which will include handling charges but not shipping charges.

Phone:	(903) 453-0802
Email Address:	info@IFIRobotics.com
Website:	WWW.IFIRobotics.com

1.6 *FIRST* ROBOTICS COMPETITION WEBSITE

Visit *FIRST* Robotics Competition at its FRC “community” area where you can find answers to administrative concerns and link to other areas of support.

<http://www.usfirst.org/community/frc/default.aspx?id=966>

- Check deadlines and dates for the Team Information Management System (TIMS), entries, grants, registration and payments, robot shipment, and awards submissions. <http://www.usfirst.org/community/frc/content.aspx?id=454>
- Find the “Documents and Updates” area, with link areas on the new “Consent and Release Form,” the NEW Archive of Email blasts, Q & A System, “2007 Robot Shipping,” FRC Team Manual sections, events, and a list of the Regional Contact persons, etc. <http://www.usfirst.org/community/frc/content.aspx?id=960>
- Fundraising support materials such as the photo gallery, video clips, and program information. http://www.usfirst.org/community/resourcecenter.aspx?id=952&menu_id=148

1.6.1 Getting Answers To Your Competition Questions

Manual and Updates: The *FIRST* Robotics Competition (FRC) Manual is available on the *FIRST* Web site at <http://www.usfirst.org/community/frc/content.aspx?id=960>. *FIRST* will update this page twice a week. The updates will contain new information and clarifications about competing at *FIRST* Robotics Competition events.

Forum: *FIRST* also provides an on-line forum for questions and answers (Q & A). It is accessible at the above web site for each section of the Competition Manual, such as "The Game," "The Robot," etc. Anyone can view questions and replies on this system. Only those team contacts with a special team username and password can post questions to this system. This username and password have been sent to the team's Main Contact.

- **FRC Q&A Forum:** To make it easier for the FRC teams to post questions, we have redesigned the FRC Game Q & A forum so that teams may post directly to the moderators of the forum. Until a moderator accepts the questions, others cannot see them.

1.6.2 Team Website Links

The website also provides links to FRC teams' home pages. If you have an FRC team-related web page, you can post it via our Team Information Management System (TIMS) as part of the registration / management process. Keep your website up-to-date with team history, projects, accomplishments, event participation, and awards for the website award review and its related deadline.

1.6.3 **NEW:** Archived Team Email Blasts

Email blasts are important communications *FIRST* sends to FRC teams. This year, all team email blasts are posted on the web site to provide team members and mentors easy access to information *FIRST* provides to, and requests from, teams since September. This feature is especially helpful for teams that register later in the season. We suggest that you have several team members in charge of updating and informing relevant persons on the team.

1.6.4 Team Updates

After the Kickoff, *Team Updates* provide rules updates, important information about parts, administrative reminders/deadlines. These documents are posted on the *FIRST* Web site. Our Team Updates schedule is Tuesday by 5PM and Friday by 10AM.

- We work hard to meet these commitments. Unexpected circumstances may, on occasions, delay their publication.
- Additional updates may be released if necessary.
- Occasionally, *FIRST* will publish revisions to manual sections.

Teams often ask one person to read all *Team Updates* and make sure the right team members are informed about their contents. Find the updates on the *FRC* “community” page after the Kickoff at <http://www.usfirst.org/community/frc/default.aspx?id=966>

1.6.5 Recruitment & Public Relations Materials

You can find information on the *FIRST* Web site to enhance your team’s recruitment efforts and find PowerPoint presentations, video clips, and statements about the Impact of *FIRST*, our Vision, testimonials, and *FIRST* financial information at:

http://www.usfirst.org/community/resourcecenter.aspx?id=952&menu_id=148

1.7 THE TIMS - SUPPLYING INFORMATION TO *FIRST*

(Team Information Management System)

The Team Information Management System (TIMS) is the on-line system to register your team and provide information to *FIRST* as the season progresses. Refer to the “Calendar of Important Deadlines” to check: <http://www.usfirst.org/community/frc/content.aspx?id=454> informational deadlines.

When teams use the system properly, TIMS provides *FIRST* with necessary, up-to-date information including:

- 1) Team Names: Official, Nickname, and the 21 letter Short Name used on the scoreboards
- 2) Team Contact information for important, team messages, shipments, and *FIRST* email blasts
- 3) Team Partner (Sponsor) information
- 4) Event attendance information for each team
- 5) Team’s FedEx or UPS shipping account number. (Purolator for Canadian teams)
- 6) Team Yearbook Page area which provides Information for judges

Additionally, TIMS “Team Information” provides options for:

- Teams willing to mentor other teams
- Teams wanting mentoring
- Entering team website address/link

1.7.1 TIMS Access for Both Main and Alternate Contacts

At the teams’ requests, we have made it possible for each team to have two **adult** TIMS access persons. Both the adult Main and Alternate contacts can enter the system with his/her logon information and make additions and changes. They are responsible for accessing the TIMS, keeping the information current, and providing necessary information by the set deadlines. Keeping the information provided in the TIMS current and accurate is critical for participation in the *FRC*.

1.7.2 International Teams

If your team is an international team, please be sure to supply your country code and city code as part of all of your phone numbers in TIMS. This is especially critical during Kit of Parts and robot shipment times because it is sometimes necessary to speak with Shipping, Main, and/or Alternate Contacts.

1.7.3 "Off Season" and Current Contact Information

Each team contact listed in the TIMS is responsible for informing the Main or Alternate Contact of any changes or additions to the team's TIMS record, including phone numbers and addresses. This is especially crucial during team travel times and during school vacations.

Be sure to provide the Main Contact's information area with a secondary address, home and cell/mobile phone numbers, and email addresses so we can reach him/her. If any of the team contacts leaves the team, add the new information and delete the former contact from the TIMS.

1.7.4 Mentoring & Team Organization

If you wish to sign up to mentor or receive mentoring through the TIMS, make sure your Main or Alternate Contact edits his/her TIMS record and clicks "yes" to the question "Share this address?" (or the email, or the phone). Find this in the primary address area.

Under "Team Information," make sure you answer the questions regarding mentoring by clicking the appropriate box regarding the following:

- We are willing to mentor other FRC teams.
- We would like to be mentored by another FRC team.

1.7.5 Team Names –Official, Short, and Nickname Deadlines

Please read below for team name definitions, uses, and TIMS deadline. Enter the information in the TIMS "Team Information" area.

1.7.5.1 Your Official Team Name

The official team name includes sponsors and schools. We refer to them as Partners. This official name is generated automatically when you enter the Partner information in the TIMS, and appears in written materials such as the *FIRST* Program Books. *Update the Partners area of the TIMS whenever there is a change or addition.*

1.7.5.2 Other Team Names for Scoreboard and Play-by-Play

Our practice and match lists must be prepared before the competition season. For this reason, we ask that you enter your short name and nicknames in the TIMS by mid January.

- 1) **Short Team Name:** Once you have established your team partners (sponsors), remember to adjust your twenty-one (21)-letter maximum "short team name" to include them. Whatever you put in this field will appear on the scoreboard at each event. Sponsors appreciate the extra recognition.
- 2) **Nickname:** Make sure to enter your team's nickname. The announcer uses team nicknames during the game when doing the play-by-play descriptions.

1.7.6 Judges' Yearbook Page

The Yearbook Page is a team overview page and is your team's opportunity to share valuable information with *FIRST* and with the judges at the Regional and Championship events. Enter the information via the TIMS under the "Pre-Event" information area.

The data you enter will help provide important statistics about *FIRST* teams. These data are very valuable for planning events and very helpful in our efforts to procure funding. *FIRST* may use the robot photos you submit in the Awards Ceremonies.

1.7.6.1 Purpose of Yearbook Page

- Provides a common starting point for judging each team

- Helps provide judges with insight into each team's workings, history, goals, strengths, and robot
- Makes judging more efficient
- Provides team data for *FIRST* and its archives

1.7.6.2 Yearbook Page Information and Deadline

The submission deadline is February 22, 2007, 11:59 EST.

Enter this data via the TIMS in the “Pre-Event Information” area.

Don’t wait until the last minute: If you wait until the deadline date to start entering information, you may have problems you can’t resolve by closing time. We face a strict printing deadline when preparing for events, and we urge you to start and complete these pages as early as you can. If you ask for help early, Team Support will have time to help, but our small staff cannot help if too many teams wait until the last days.

No Time Extensions: *FIRST* cannot grant time extensions to complete this information.

1.7.6.3 Required “Pre-Event” Information

To prepare for this project, you may want to gather information about your team. Put in your data in your TIMS record as you gather it. The following is an idea of the type of information you will need for this area:

- Number of years team has been involved
- Name of the Student Leader
- Team Budget for the year
- Robot or robot and team photo
- Number of female and male students, engineers and technicians, teachers, and parents on the team
- How many freshmen, sophomores, juniors, seniors
- Teacher/Mentor information
- Percent of your school's student population receiving free or reduced-price lunch

Essay Portion – Please answer briefly. This section requires short, written descriptions of the following:

- Team history
- Team goals
- *FIRST* impact on the team/community
- Community description
- Team strengths
- Most significant challenge the team overcame
- Robot game and strategy
- For which awards is the Team is most competitive this year?
- Funding sources

Why is the public aware of your team?

Photo: In the designated spot on the web page, insert a single digital photo of the robot, or the team and robot. Judges rely on these photos, and they also help *FIRST* with media coverage and awards ceremonies.

Format: The Main Contact for each team will receive the necessary instructions for filling out the form via the TIMS. To ensure proper archiving, carefully follow the directions.

1.8 Autodesk CONTACT INFORMATION

Website: Autodesk has created a website area devoted to *FIRST* teams, called FIRSTbase. Please go to www.autodesk.com/firstbase for information on the software downloads, training, the Autodesk competition, Autodesk kit of parts, technical support, their sponsorship, *FIRST* alumni, resources, frequently asked questions, the pressroom and feedback. You can find the initial email on the archive page <http://www.usfirst.org/community/frc/content.aspx?id=3520>**Email:** If you can't find answers to your questions from the above website, please contact Autodesk via first@mail.autodesk.com

1.9 EVENT-SPECIFIC INFORMATION

The *FIRST* Robotics website includes important information about specific events. We advise that you add copies of the "Site Info" and "Shipping / Drayage" and any information you receive regarding the FedEx donated shipping process to your FRC Manual information regarding the events you will attend.

You will be able to download the below information for the events, and you can find this information on the *FIRST* Robotics page by clicking on Regional Events or Championship. Choose your event and click on "Site Info" or other links for pertinent information, such as pre-order lunch forms. Provide the information to appropriate team members and mentors.

- The **NEW** 2006-07 Consent and Release Form - only acceptable version of the form for the 2007 Kickoff and events. Bring completed copies in case the originals are lost or the person carrying them is delayed. These are due at registration of your initial competition event.
- Site Maps
- Shipping and drayage information and labels
- Copies of pre-ordered lunch forms
- Team social events
- Be sure to include your FedEx airbills, directions for airbill printing, and logon information

1.10 **NEW:** REGIONAL EVENTS HOTEL SEARCH INFORMATION

For the 2007 season, *FIRST* will not be offering hotel reservation services for the *FIRST* Robotics Regional event season. We are working hard on having the service reinstated next year. In the meantime, we would like to provide *FIRST* team mentors with some recommendations for placing team hotel reservations. Some great resources are:

- Google/Kayak
- The Convention and Visitors Bureau (CVB) in the city in which you are competing. Hotels that are members of their local CVBs tend to be more reputable properties.

Examples: www.atlanta.net, <http://www.visitdetroit.com/>, <http://www.orlandoinfo.com/>

NOTE: If you can't get a large enough block from a third party website such as Travelocity or Price.com, contact the hotel directly during normal business hours to speak with a reservations representative who is better suited to make larger blocks.

We suggest that you use the following tips to help with your hotel search.

- 1) Pick out three or four hotels in the same proximity of your Regional city to confirm approximate pricing for the marketplace within 3-5 miles to the venue. You can find a complete list of venue addresses for the Regionals on the *FIRST* Web site.
- 2) Use Mapquest, Yahoo, or other online driving direction services to confirm the distance to the venue.
- 3) Once you make your choices, contact the hotels reservation personnel and ask your questions directly. The following are examples of what features you will want your hotel to have:
 - 24 hour security
 - Free parking, or at least secure parking if it is in a city environment
 - Interior entrance rooms - rooms that have exterior entrances are the ones that have inherent security risks, plus the fact that any team member can wander off at any time.
 - Hotels that have been renovated within the past 4 years
 - Hotels that will disclose if they have groups in house that are not consistent with or are in indirect opposition to *FIRST* values or any other groups that tend to stay up late and can affect your sleep.

Other items to consider are:

- Will your room block be together on the same floor/area
 - Is there a complimentary breakfast
 - Is there free Internet access (about 50% of all hotels have it)
 - Cheapest should not be the only qualifier. If the quality or location is poor, it can lead to an overall bad Regional experience. Without the proper sleep, you will wish that you had paid a little more for a better quality hotel.
- 4) Call and make your reservations as soon as possible. What rates you may find available now are not usually the same close to the event date when the hotel is close to its capacity.

1.11 CHAMPIONSHIP HOTEL INFORMATION

FIRST is pleased to announce that Steele Meetings, Inc will be handling the hotel reservation system in Atlanta for the 2007 *FIRST* Championship. Click on the link [hotel reservation](#). To contact Steele Meetings at any time, write to Linda Steele at steelemeetings@earthlink.net.

1.12 *FIRST* LOGOS

You have numerous creative opportunities for designing your own team identity. Every year we see great examples of how teams "brand" their efforts with websites, incredible team logos on robots, T-shirts, hats, banners, fliers, and giveaways. These branding activities are a wonderful way to include students from art, communications, computer, and language arts classes.

As you manage your own promotion, you may want to incorporate the *FIRST* logo in what you do. Because our mark - the combination of the composite graphic element plus the *FIRST* wordmark - is registered, we have a few guidelines for you to follow when using the *FIRST* logo.

You can find the *FIRST* Logo on FRC Communications Resource Center <http://www.usfirst.org/community/resourcecenter.aspx?id=650>

1.12.1 Logo Use

We encourage teams to develop and promote team identity. It is a great way to help *FIRST* judges, announcers, and audiences recognize your team at the competitions, and it is also a way to help you create a community "buzz" about your team. Here are some guidelines:

Positive Promotion: Use our logo in a manner that is positive and promotes *FIRST*.

Unmodified: Use the *FIRST* logo without modification. This means that you will use our name and the triangle, circle and square as you see it on our website or letterhead. You can use it in red, blue, and white, or in black and white. Refer to the *FIRST* logo standards for additional details including placement, size, and color specifications and incorrect logo usage.

Logo and Standards: You can download the *FIRST* logo from our website in JPEG (for electronic applications) or eps (for printed applications) format. Go to <http://www.usfirst.org/> and click on FRC Communications Resource Center in the Quicklinks menu. Select the “Graphics” Section.

Advertising Use Approval: All teams and sponsors must obtain approval from *FIRST* prior to incorporating our logo in any advertising. Email approval requests to Marian Murphy, murphy@usfirst.org or phone 800-871-8326, ext. 409.

1.12.2 Finding This Year’s Competition Logo

Once the game is announced at the Kickoff, you will soon be able to download this year’s game logo from the *FIRST* Robotics Competition Communications Resource Center portion of the website under “Graphics.” <http://www.usfirst.org/community/resourcecenter.aspx?id=650>

1.13 PROVIDING CORPORATE SPONSORSHIP

For those interested in providing Corporate Sponsorship to *FIRST*, please contact Dia Stolnitz, Director of Annual Giving, for information regarding the opportunity to provide sponsorship at (603) 666-3906 or (800) 871-8326, Extension 406. You can also contact him via email at dstolnitz@usfirst.org.

1.14 HOW TO VOLUNTEER FOR *FIRST*

Each Competition event depends on an abundance of volunteers with a broad spectrum of talents to support operating needs and competition demands. If you have time, we appreciate and can surely use your help. Please visit the *FIRST* Web site page, “For Volunteers,” to find out more about volunteer opportunities. You can register your preferences for events and volunteer positions via the *FIRST* Volunteer Information and Matching System (VIMS), an on-line registration system.

Section
2

TEAM ORGANIZATION



TABLE OF CONTENTS

2 TEAM ORGANIZATION	2
2.1 OVERVIEW.....	2
2.2 REQUIRED CONTACT POSITIONS FOR THE TIMS.....	2
2.2.1 TIMS Maintenance	2
2.2.2 Distribute Information	2
2.2.3 NEW: E-mail Blast Archive.....	2
2.3 SUGGESTED LEADERSHIP ROLES.....	2
2.3.1 Main Contact	3
2.3.2 Alternate Contact.....	4
2.3.3 Shipping Contact.....	4
2.4 RECOMMENDED ADDITIONAL CONTACTS.....	5
2.4.1 Travel Contact	5
2.4.2 Public Relations Contact	6
2.4.3 School Contact	6
2.4.4 Corporate / University Contact	7
2.4.5 Technical Contact.....	7
2.5 OTHER IMPORTANT TEAM POSITIONS.....	8
2.5.1 Game Rules Monitor	8
2.5.2 Safety Captain.....	8

2 TEAM ORGANIZATION

2.1 OVERVIEW

One of the most critical aspects of running a team is keeping abreast with current information and deadlines, so ensure your team has a good system for that. This section talks about required and optional team contacts and their roles. By listing these tasks, you will get an overview of what the project entails and how you can share the projects. Keep team members and mentors up-to-date, watch deadlines, and spread around the workload.

2.2 REQUIRED CONTACT POSITIONS FOR THE TIMS

The Main and Alternate Contacts receive the majority of the communications from *FIRST*, and they are usually in charge of disseminating the information. They are also responsible for keeping the team's Team Information Management System (TIMS) record up-to-date. The Shipping Contact has to know all about shipping the team's robot and receiving any program-related shipments.

- 1) Main Contact
- 2) Alternate Contact
- 3) Shipping Contact

2.2.1 TIMS Maintenance

Communications between *FIRST* and teams is essential, and each team-designated contact person should inform the team's Main or Alternate Contact of any change in phone numbers, mail address, or e-mail address so he/she can update the Team Information Management System (TIMS). Multiple phone numbers and e-mail addresses are necessary so we can contact team contacts during vacations, school shutdowns, and while the team is traveling. It is essential that the team record is kept up-to-date. We also suggest that you keep a hard copy of your team's contact information. Use pencil so you can make changes and distribute updated copies to the team.

2.2.2 Distribute Information

Distributing information received from *FIRST* Headquarters is important. The Main and Alternate Contacts will receive the majority of communications. They should disseminate information to relevant team and sub-team members and mentors.

We recommend highlighting specific topics of the communication. Reminding team members of specific responsibilities and impending deadlines is essential. Use a team bulletin board for *FIRST* e-mail blasts, team happenings, and meeting times and topics.

2.2.3 **NEW:** E-mail Blast Archive

We refer to e-mail blasts when we talk about a message sent to all FRC teams via e-mail. They can contain new information, a deadline reminder, or an opportunity for teams. We have archived the e-mail blasts sent since September so all teams can refer back to their contents. This is especially helpful for rookie teams who registered after the mailings.

2.3 SUGGESTED LEADERSHIP ROLES

This section recommends various team contact duties and responsibilities that are essential to maintain the competitive team effort of the season. ***Main, Alternate, and Shipping Contacts must be adults. Pre-college students are not permitted in the TIMS.***

Your team will ultimately decide which individual duties it will adopt and ensure that the individuals are capable of performing the assigned tasks. It is the responsibility of these team leaders and other team mentors to establish, instill, and enforce team rules with regard to safety, sportsmanship, and conduct. It is essential that team members and mentors share the workload and equally commit to the team's success. Ensure everyone understands the various roles enough to be able to cover if necessary.

Examine the roles, and compare recommended qualities and abilities with your mentors from a *FIRST* perspective. *Team structure is the team's prerogative and the following are suggestions.*

2.3.1 Main Contact

The Main Contact is the main source through which most information flows from *FIRST* to the team. This person may choose to delegate some of the responsibilities listed below, but should still be up-to-date with their progress and ensure their completion.

Responsibilities	
Communications:	Receive <i>FIRST</i> communications and reply when necessary. Review Safety Policies and Procedures on the <i>FIRST Web site</i> and ensure all team members have this information.
Contact Information:	Verify up-to-date alternate mailing addresses and phone numbers are posted to the TIMS for use during vacations or team travel.
Event Information:	Supply event information to <i>FIRST</i> , via the TIMS.
<i>FIRST</i> Information distribution:	Receive and disseminate all information from <i>FIRST</i> , including E-mail Blasts and Updates from the website, and to handle replying/complying with <i>FIRST</i> requests.
FedEx Donation:	Confirm the Shipping Contact understands the FedEx donation process and use of the on-line FedEx Shipping Administration System. (Formerly Passkey) See Section 4 of FRC Manual.
On-Line Submissions	Ensure submissions of Woodie Flowers, Website, Chairman's, and other Awards by the respective deadlines. Find details in the "Awards" section of the FRC Manual.
Participation Medallions:	Ensure they are obtained at your team's initial event. Refer to the "At the Events" of the FRC Manual for details.
Registration:	Register the team for events.
Release Forms:	Designate someone to distribute 2006-07 NEW Release Forms and collect the completed signed forms. They must be presented at the team's initial competition registration of 2007. NOTE: The forms for students under 18 require a parent/legal guardian's signature. They are required for: Kickoff events Any of the <i>FIRST</i> Regional or Championship events. If a person does not attend the team's initial event, he/she must still provide one at a subsequent event. You must turn them in at that event.
Safety:	Work together with your team's Safety Captain and entire team to ensure safety while working and traveling.
Scholarship Opportunities:	Keep students/teachers informed about scholarship opportunities well in advance of the deadlines. http://www.usfirst.org/community/frc/content.aspx?id=512
Team logon and password:	Receive, and keep secret, your TIMS logon and password.
TIMS (Team Info System):	Maintain and update team's TIMS record.
Updates and archived e-mails:	Disseminate e-mails, and web "Updates" information to relevant sub-teams. Refer to the web for archived e-mails.

UPS, FedEx, Purolator Account Number for TIMS:	Enter the team's UPS or FedEx number for the TIMS. This is mandatory. The Shipping Contact should obtain this and provide it to the Main Contact. A sponsor or your school may let you use their account, or you can get a number from either shipping company's website.
Website Calendar:	Monitor the <i>FIRST Web site</i> calendar for changes, additions.
Yearbook Page:	Enter this submission into the TIMS by the deadline.

2.3.2 Alternate Contact

This person is the Main Contact's "right hand" and is important in the team's structure. He or she should share the team administrative duties, be ready to help in ways the team decides, delegate responsibilities when necessary, and cover the Main Contact's role if that becomes necessary.

Responsibilities	
Communications:	Receive relevant <i>FIRST</i> communications and reply when necessary. <u>Chairman's Award project</u> - Ensure any unusual stories about overcoming obstacles are included in the Chairman's Award submission.
Contact Information:	Provide current contact information for the TIMS, including an alternate phone number and address in case <i>FIRST</i> has to make contact during vacation or while the team is traveling..
Public Relations:	Confer with Main Contact. Notify Public Relations Contact of any upcoming team fundraising or events.
Safety:	Work with team's Safety Captain to ensure safety while working and traveling.
Shipping:	Be familiar with the shipping and drayage responsibilities and deadlines in case the Shipping Contact needs help.
Scholarship Opportunities:	Inform students of scholarship opportunities and their deadlines. http://www.usfirst.org/community/frc/content.aspx?id=512
Support:	Provide any support the Main Contact/team may need.
Team Logon and Password:	Receive, and keep secret, your Team Information Management System (TIMS) logon and password.
Vacation Coverage:	The Main Contact and the Alternative contact will receive and be asked to disseminate <i>FIRST</i> communications.
Website Calendar:	Monitor the <i>FIRST Web site</i> calendar for changes, additions.

2.3.3 Shipping Contact

This person is responsible for handling both robot shipping and drayage arrangements for the team as well as receiving mailed items for the team.

Responsibilities	
Kit of Parts:	<p>If your team opted to pay for your Kit of Parts shipment, confer with Main/Alternate Contact to ensure that the shipping address in the TIMS is viable ("My Site" choice)</p> <p>If the team wants to pick up the kit, make sure the Main Contact meets the deadline for this TIMS entry by November.</p> <p>Pick up or designate an adult mentor to pick up the kit at a Kickoff.</p>
Communications:	Receive relevant <i>FIRST</i> communications, replying and forwarding when necessary.

Contact Information:	Provide the Main Contact with current contact information for the TIMS, including an alternate phone number to enable <i>FIRST</i> contact during vacation or while the team is traveling.
FedEx Donated Shipments: Obtain and maintain airbills	Read the “Robot Transportation” Manual Section and become familiar with the FedEx shipping donation, its specifications, and the related on-line system for teams in the contiguous states. Write down the airbill storage place, and tell someone else where they are in case you forget their location. The airbills are not replaceable.
Robot Shipment	Read the “Robot Transportation” Manual Section and download your event(s) from the Events portion of the website, “Site Info.” http://www.usfirst.org/robotics/2007/rgevents.htm Be familiar with and conform to the following: Deadlines and specifications for shipping your robot and additional crate The drayage system and its deadlines and specifications On-time robot shipment within the <i>FIRST</i> specifications. <u>Domestic Teams:</u> Be completely familiar with the FedEx on-line shipping system and how to print airbills. <u>Teams from AK, PR, HI:</u> Become familiar with the FedEx donation system and keep airbills safe. <u>International Teams:</u> Become familiar with the FedEx donation system and keep the airbills safe. Be familiar with all Customs shipping and receiving requirements.
Team's UPS, Purolator, or FedEx Account Number:	Provide the Main or Alternate Contact with a shipping account number for inclusion in the TIMS. This is a necessary and a mandatory portion of the <i>FIRST</i> system and directly impacts the missing, defective, or broken parts replacement system for your team. (A sponsor or your school may let you use their shipping number, or you can get your own number from the companies' websites).

2.4 RECOMMENDED ADDITIONAL CONTACTS

2.4.1 Travel Contact

This person will be making event(s) travel and hotel arrangements for the team members and mentors. It is important to tackle this task early enough to ensure there is room on preferred flights and in preferred hotels.

Responsibilities	
Communications:	Receive relevant <i>FIRST</i> communications and reply when necessary.
Travel Pricing:	Obtain, consider, and compare travel costs prior to registering for an event(s). The web has many opportunities to compare airfares. Ask for group rates to see if that is a good option. Is bussing an option?
Contact Information:	Provide up-to-date contact information for the TIMS. Provide an alternate phone number and address in case <i>FIRST</i> needs to make contact during vacation or while the team is traveling.

Hotel Reservations:	<p><u>Regionals</u>: Refer to the “Communications” section of the Manual for hints and good advice on choosing hotels for your team.</p> <p><u>Championship</u>: Use the <i>FIRST</i> vendor, located on the web site, to obtain reasonable hotel packages for the Championship.</p> <p>Conform to the <i>FIRST</i> guidelines and deadlines regarding travel.</p>
Manual and Website:	Become familiar with associated duties. Refer to the “Site Info” on the web site for any special travel or parking instructions.
Stores:	Refer to the “At the Events” portion of the Manual to find links to various types of stores, such as printing, supplies, hardware. Find stores near your chosen event and print out the directions to them.

2.4.2 Public Relations Contact

This person's role in advertising the team's goals and accomplishments is critical. Work with the team contacts to ensure the partners are apprised of the team's progress and accomplishments.

Responsibilities	
PR Updates:	Responsible for receiving and disseminating any PR updates and using them to the team's advantage in local newspapers, as well as television and radio stations.
Fundraising:	The team would be wise to advise this person of any fundraising activity or team appearances well before the date.
Sponsors:	Send any PR information to potential sponsors all during the year.
Contact Information:	Provide up-to-date contact information to the Main Contact for the TIMS.
Communications:	Receive relevant <i>FIRST</i> communications and reply when necessary. Supply up-to-date contact information to Main Contact for the TIMS.

2.4.3 School Contact

This adult representative is responsible for knowing and enforcing all school rules regarding team participation. A teacher or principal may be best qualified for this role. He or she has a huge role in facilitating the team's progress, meeting deadlines, and is very often the team's main contact also.

Responsibilities	
Communications:	<p>Receive school related team e-mails. Provide information/reply if necessary.</p> <p>If no one is specified to work on the following projects, work with Main Contact to make sure students get them done. Refer to the web <i>Deadline Calendar of Important Events</i>. Check with other team mentors for information.</p> <p><u>Chairman's Award project</u> - Continuously help record/document any unusual stories about the team overcoming obstacles during the year.</p> <p><u>Woodie Flowers Award</u> (Look in on-line Manual, “Awards Section.”)</p> <p><u>Yearbook Page</u>.</p> <p><u>Website Award</u></p> <p><u>Autodesk Awards</u></p>
Contact Information:	Provide up-to-date contact information for the Main Contact/the TIMS
Public Relations:	Notifying Public Relations Contact of any upcoming team fundraising or events. Conferring with Main Contact.
Safety:	Stress safety whenever possible.

Scholarships:	Inform students early about scholarship opportunities and deadlines, and encourage and assist those interested in applying for them.
---------------	--

2.4.4 Corporate / University Contact

This contact provides information about the team to the University or Corporation sponsoring the team. Keeping the sponsor/partner informed of team progress and achievements throughout the season is a great way to ensure their support.

Responsibilities	
Communications:	Receive related team e-mails. Provide information if necessary.
Contact Information:	Provide up-to-date contact information for the Main Contact for the TIMS. Provide an alternate phone number and address in case <i>FIRST</i> needs to make contact during vacation or while the team is traveling.
Public Relations:	Notify university/sponsor contacts of any upcoming team fundraising or events. Confer with Main Contact. Let supporters know about trials and successes regarding the robot design and build. Get them excited right through the process and continue providing information throughout the year. Invite them to an event.
Scholarships:	Inform students about scholarship opportunities and deadlines. Encourage and assist students interested in applying for them.

2.4.5 Technical Contact

This person will assist the team with technical issues and problems related to engineering.

Responsibilities	
Communications:	Receive relative team e-mails. Provide information/reply if necessary. Keep the rest of the team apprised on your technical successes/failures. Ask for help/ideas. Chairman's Award project - Help students document any unusual stories about the team overcoming obstacles during the year.
Contact Information:	Provide up-to-date contact information for the Main Contact and TIMS. Provide an alternate phone number and address in case <i>FIRST</i> needs to make contact during vacation or while the team is traveling.
Pre-Ship Inspection:	Work with the team members to perform a robot inspection before your robot ships. Use the Inspection Sheet that will be posted on the web. This inspection will show where problems are so you can correct them before shipment. It will also provide the students with information they will need to know during the on-site, pre-competition inspection since the inspectors will be asking the students questions.
Public Relations:	Notify Public Relations Contact when your robot nears completion or when you have an opportunity to show off your robot. If the Public Relations contact is not available, notify local media of any upcoming team fundraising or events. Plan these opportunities with your Main Contact.
Safety:	Stress safety and ensure safe working conditions, safety glasses use, etc.
Scholarships:	Encourage students to try for engineering and technical scholarships. Inform them of the deadlines.

2.5 OTHER IMPORTANT TEAM POSITIONS

Your team may want to consider appointing one or several Rules Monitors and Safety Captains. Students are welcome to fill these positions if the team members and mentors agree and find responsible candidates. *FIRST* does not need their contact information in the TIMS.

Please read below for some job-related roles these students or adults may want to fill. There will be one Safety Captain badge at the team's first event for each team's Safety Captain. If a team has more than one captain, these persons can take turns wearing the badge at the events.

2.5.1 Game Rules Monitor

Responsibilities	
Learn Game Rules:	Read and understand the rules of the game and communicate them to the team members so they know the ins and outs of the game.
Know Point System:	Be sure the team understands the system; implement the best strategy.
Know Penalties:	Be sure all mentors and operators know and understand all penalties.
Learn Web System:	Check the on-line Manual for rules, changes, and web-based question and answer system.
Monitor Team Updates:	Communicate any changes in the updates to the team.

2.5.2 Safety Captain

Responsibilities	
Read Manual:	Read "Courtesies and Rules" in the "At the Events" section of the Manual. Meet with team members and decide what the team deems important in the safety area. Diplomatically enforce their findings.
Home Work Site:	Obtain enough safety glasses for the team. Ensure all persons wear them over their eyes when working on the robot or in the "work" vicinity. People who wear glasses must have regulation safety glasses with side shields or wear safety goggles over their glasses. Make sure the work area is safe and the floor is clear.
Safety Policies:	Review Safety Policies and Procedures on the <i>FIRST Web site</i> and ensure all team members have this information and understand the importance of each person following them.
Use Courtesy:	At all times, think with a "gracious professionalism" attitude. Be courteous and helpful, not bossy or rude. This position is one that should make teams aware of safety issues and make team members want to improve conditions, not balk at the methods we use to ensure a safe environment. Use common sense and good judgment when bringing an infraction to a team's attention. Please be kind and positive. The Safety Captain is an ambassador for your team.
At Competitions:	Bring enough safety glasses for the team and its guests. Make sure persons who will unpack your robot crate will have them to wear as they arrive at the Pit. Make sure all persons wear safety glasses/goggles properly. Know where the EMT area is. Report any injuries to the Pit Supervisor at the time of injury or treatment. Discourage running in the Pit or Competition Arena. Help keep Pit aisles clear. Bring any serious safety infractions, such as metal grinding or open flames to the attention of the Pit Supervisor, as well as any blatant discourtesies.

Section
3

AT THE EVENTS



TABLE OF CONTENTS

3 AT THE EVENTS 3

3.1 OVERVIEW..... 3

3.2 *FIRST* SPECIFIC EVENT INFORMATION..... 3

3.3 *FIRST* SAFETY..... 3

 3.3.1 Safe Travel..... 3

 3.3.2 Staff/Volunteer Badges..... 3

 3.3.3 Safety Captain Badges..... 3

 3.3.4 NEW: Mandatory Safety Glasses - They aren't forehead protectors 3

 3.3.5 NEW: Safety Manual 4

 3.3.6 NEW: Other Safety Recommendations..... 4

 3.3.7 NEW: Robot Carts 4

 3.3.8 NEW: Safety Recognition Program..... 4

3.4 SAMPLE COMPETITION AGENDAS..... 5

 3.4.1 Regional Competitions..... 5

 3.4.2 Championship Agenda 7

3.5 COMPETITION OVERVIEW 7

 3.5.1 Practice Rounds 7

 3.5.2 Official Robot Inspection..... 7

 3.5.3 Competition Matches..... 8

 3.5.4 NEW: Practice Field..... 9

3.6 TEAM REGISTRATION 9

 3.6.1 NEW FORM - Consent / Release Forms – *NEW Version Required* 9

 3.6.2 Registration Envelope..... 10

3.7 THE PIT 10

 3.7.1 Be Safe, Be Kind, Be Gracious..... 10

 3.7.2 Administration Station..... 11

 3.7.3 Pit Map..... 11

 3.7.4 NEW: Team Stations 11

 3.7.5 Aisles..... 12

 3.7.6 Suggested Equipment 12

 3.7.7 Replacement Kit Parts Availability at Events..... 12

 3.7.8 Control Systems 12

 3.7.9 Machine Shop..... 12

 3.7.10 Announcer..... 13

 3.7.11 Robot Traffic Flow..... 13

3.7.12 Queuing.....	13
3.7.13 Property Security	13
3.7.14 Lost and Found.....	13
3.7.15 First Aid	13
3.8 OPENING AND AWARDS CEREMONIES.....	14
3.8.1 All Teams Should Attend	14
3.8.2 Pit Manners/Rules During the Ceremonies	14
3.8.3 NEW: Pit Closing Etiquette	14
3.9 TEAM SOCIALS.....	14
3.9.1 Requirements	14
3.9.2 Regional Socials.....	14
3.9.3 Championship <i>FIRST</i> Finale.....	15
3.10 PARTICIPATION MEDALLIONS.....	15
3.10.1 One-Time Pickup at Team's Initial Event	15
3.10.2 If You Forget to Pick Up Your Medallions	15
3.11 TEAM SPIRIT AND STYL'N.....	15
3.11.1 Mascots and Team Costumes	15
3.11.2 Competition Spirit	15
3.11.3 Banners and Flags - Rules	16
3.11.4 Saving Seats Not Allowed.....	16
3.12 SITE RESTRICTIONS.....	16
3.13 COURTESIES AND RULES.....	17
3.14 CONSIDERATIONS.....	17
3.14.1 Donated Software Use/Restrictions	17
3.14.2 Sharing Fundraising Ideas.....	17
3.14.3 Pit and Competition Safety	18
3.14.4 Courtesy and Site Regulations.....	18
3.15 LOCAL STORES - WEBSITES	19
3.16 HOT REMINDERS AS YOU PACK.....	20
3.16.1 Packing; Team Checklist	21

3 AT THE EVENTS

3.1 OVERVIEW

This section provides a general summary regarding a safety, mascots/uniforms, recommended items and equipment for teams to bring, Pit rules, generic event schedules, robot inspections, replacement parts, and competition manners. The following section provides a "feel" for competition schedules, registration procedures, practice times, and matches. Please familiarize your team with this overview so all team members know what to expect and understand the routine and the rules.

Please notice and carefully read the “**NEW**” items in all sections of the Manual.

3.2 FIRST SPECIFIC EVENT INFORMATION

To ensure that your team has the proper Regional information for its event(s), download Regional/Championship sections from the *FIRST Web site* for the events you will attend. These sections are only available on the *FIRST Web site* and contain critical event-specific information on pre-order lunches, agendas, event addresses/directions, and team socials.

<http://www.usfirst.org/community/frc/>

3.3 FIRST SAFETY

Participants and team mentors should review the *FIRST* safety policies and the *FIRST* Robotics Competition Team Safety Manual” on the *FIRST Web site* for good safety practices at your workplace and at *FIRST* events. Everyone should also review the “Site Restrictions” in the “Site Info” event postings. Every team should know, understand, and follow the safety recommendations and rules.

3.3.1 Safe Travel

Travel in pairs or larger groups at all times going to, coming from, and during each event. Be sure to include enough informed chaperones, specified meeting places in case someone gets separated from the group, contact information for those traveling, and a room list for hotel stays.

Be sure to specify a meeting place for your group in case of fire or evacuation at the hotel or at an event. Keep an accurate team count and have your team use the buddy system.

3.3.2 Staff/Volunteer Badges

At events, staff and volunteers will wear distinguishing badges. Should your team members or mentors have questions or a problem, most staff and volunteers will help you find the answer, especially the pit administration staff.

3.3.3 Safety Captain Badges

Each team should appoint a safety captain, adult or student, who will observe and make suggestions for a safe workplace and work methods prior to and during the competition events. He or she will receive a badge at the team’s initial competition event and should strive to maintain a safe environment for the team’s home workplace and at each competition event.

3.3.4 **NEW: Mandatory Safety Glasses - They aren’t forehead protectors**

NEW: *FIRST* requires all teams to bring and supply, for each competition, ANSI-approved **non-shaded** safety glasses for its team members, mentors, and guests.

For our purposes, amber lenses that allow for better/brighter vision are considered tinted, not shaded, and their use is allowed at *FIRST* events. Sunglasses or deeply shaded safety glasses used in our indoor event environment are not acceptable.

Students and adult team members and guests must wear approved safety glasses when:

- **NEW:** Entering the Pit
- Uncrating the robot
- **In the Pit, everyone must wear them at all times**
- Working on the robot
- When observing any robot building/repair work
- While competing – mentor, human player, 2 operators

Operators, players, and mentors will not be allowed on the competition field without approved safety glasses. Regular glasses do not qualify as safety glasses, and *you must use approved safety goggles over them*. Goggles are not required over glasses if the glasses are ANSI-approved with side shields.

3.3.4 NEW: Safety Manual

The “*FIRST* Robotics Competition Team Safety Manual,” a must read for safety captains, is posted on the web, and contains safety information, suggestions, and a checklist. The team should be familiar with its contents about safety at the workplace and at events.

3.3.5 NEW: Other Safety Recommendations

At events, the pure anticipation and excitement of being at the competition sometimes overshadows common sense and safety fundamentals. One safety area that teams sometimes overlook is the particular need to wear appropriate and proper clothing when working or just hanging around the robots. In addition to the ANSI-approved safety glasses required for eye protection, *FIRST* also highly recommends that team members and mentors:

- Don't wear loose or baggy clothing near the robots
- Wear proper shoes to protect feet and toes
- Wear gloves to protect hands and fingers when carrying the robot or handling the robot crate.
- Tie back long hair so that it will not get caught in the robot or machinery

3.3.6 NEW: Robot Carts

To protect team members and mentors from muscle strains and other injuries as they transport the heavy robot from the Pit to the competition area, we recommend that team members and mentors use some type of cart, keeping the following in mind.

- Carts must remain in the team pit area when not in use for robot transportation
- All carts should fit through a standard 30-inch door
- Wheels on the cart must not damage site flooring
- Do not add music to the cart.

Prior to competing, your competition team should practice lifting your robot onto and off your cart. Refer to the “*FIRST* Robotics Competition Team Safety Manual” for robot lifting techniques. By practicing these safe techniques, your team members will also develop a quick, fluid routine.

3.3.7 NEW: Safety Recognition Program

Quoting from the *FRC Team Safety Manual*, “Instilling a culture of safety is a value that every facet of the *FIRST* community must embrace as it pursues its mission and vision. We encourage

the whole *FIRST* Robotics Competition (FRC) to adopt safety as a core value and establish the right framework for safety leadership in all aspects of our endeavors.

The Safety Advisors will rate safe performance in three key areas:

- 1) Safe Behaviors
- 2) Physical Conditions
- 3) PPE use (Personal Protective Equipment)

Throughout the competition, the easily recognizable, green-shirted Safety Advisors will continuously tour in pairs to observe activities in the Pit, practice field, queue line, and playing fields to critique the safety habits of the teams. This includes observing the uncrating of robots and transporting them between the Pit and playing fields. Safety Advisors will use plastic safety tokens, or credits, to recognize and encourage safe behaviors at the competition. Teams will earn tokens for positive safety habits in the above areas.

Teams will receive 10 safety tokens in the registration packet and should keep 5 of them and distribute the other 5, in whatever denomination they wish, to teams worthy of best safety practices. Teams will return the tokens to the Administration Station for a final count on the last competition day.

The three teams accruing the most safety tokens will be announced during the Awards Ceremony and can collect their "safety pins" at the Pit Administration Station after the ceremony.

3.4 SAMPLE COMPETITION AGENDAS

Print the event-specific agenda from the web site for each event you will attend. Bring it with you so your team will have the schedule. <http://www.usfirst.org/community/frc/regionalevents>

The following agendas are approximations.

3.4.1 Regional Competitions

First Day **Limited pit opening is limited to robot uncrating and battery charging only.:**

3 persons per team admitted to prior to pit opening, usually 7:45 a.m. **This early opening time is not for team station setup, work on the robot, or registration.**

Team arrival. Pit usually opens about 8:30 a.m.

Registration - Release form collection, before noon

Practice rounds

Official weigh-in and inspection

Pit closes not later than 8 p.m.

Second Day Pit opens, usually about 8 a.m.
Team lineup begins about 8:30 a.m.
Opening ceremony, about 9 a.m.
Seeding (qualifying) matches
Awards ceremony
Pit closes not later than 6 p.m.
Team Social, if applicable

Final Day Pit opens, about 8 a.m.
Opening ceremony, usually about 9 a.m.
Continued seeding (qualifying) matches
Elimination matches, usually about 1 p.m.
Awards ceremony
Bronze medallion pickup at the Pit Administration station
Chairman's Award submissions returned

Pit closes not later than 5 p.m. - Robots packed for shipping

3.4.2 Championship Agenda

Wednesday Evening	Limited Pit opening from 6 to 9 p.m. so 3 persons per team can uncrate the team robot and charge batteries only. This time is not for team station setup or robot work.
Thursday	Team arrival. Pit usually opens about 7:30 or 8:00 a.m. Registration upon arrival and before noon Practice rounds Official weigh-in and inspection Pit closes not later than 8 p.m.
Friday	Pit opens, usually about 7:30 or 8 a.m. Team lineup begins at 8:30. Opening ceremony about 9 a.m. Seeding (qualifying) matches Pit closes not later than 6 p.m.
Saturday	Pit opens, usually about 7:30 or 8 a.m. Opening ceremony Continued seeding (qualifying) matches Elimination matches, about 1 p.m. Awards ceremony Teams receive returned Chairman's Award submissions before Pit closes Pit closes not later than 5 p.m.- Robots packed for shipping, pit stations clean <i>FIRST</i> Finale usually about 6:30 to 9:30 p.m.

3.5 COMPETITION OVERVIEW

This section provides general competition information and necessary details with regard to scheduling, robot inspection, practice times, safety, rules, regulations, and suggestions for teams.

3.5.1 Practice Rounds

Your registration envelope will contain a list of practice times for the first day. Practice rounds take place on the competition field. The list will indicate on which competition field you will practice and with what teams. *Teams cannot switch practice times.*

3.5.1.1 Time Slots

All teams will receive a list of all the practice times. Your team must be ready to practice at the designated times and on the specified fields. If your team/robot cannot be ready for your practice time slot, don't forfeit your team's practice time entirely. Send in your human player to practice alone. Your team members may want to scout other teams and their strategies during practice and the actual competition matches.

3.5.1.2 Courtesy

In order to make the most of practice time, there will be specified teams on a field during an assigned practice slot. Each team must be respectful of the other teams sharing the field. Friendly interaction between machines is acceptable if all teams are willing. Un-sportsman-like conduct on the part of a team during practice could result in loss of practice time.

3.5.2 Official Robot Inspection

To ensure all robots are safely constructed and fall within the *FIRST* parameters, there is an official robot inspection at each event. *FIRST* staff and volunteers will be on site all day on the first day of the event, until Pit closing time, to inspect machines.

Inspectors can sometimes help find problems and/or provide suggestions during an early inspection. Go to the Inspection Station, which will be shown on the Pit map. Please read below for criteria and caveats:

- 4) To ensure safety and readiness, pre-inspect your robot before you ship it. This will make your official inspection go more smoothly and quickly.
- 5) Inspectors will use an Official Inspection sheet for checking robots; a draft copy of the inspection checklist will be available to teams during the build season. Inspectors check off items on an Inspection Sheet as the team passes those portions of the process.
- 6) Don't wait until the last moment to begin the process. Bring your robot to the Inspection Station early. Partial inspections, such as for height and weight compliance, help prevent an inspection clog at the end of the day.
- 7) Student team members must accompany the robot and be prepared to answer Inspectors' questions.
- 8) Return with corrected items until your robot passes inspection.
- 9) Teams may practice on the first day of the event without completing the inspection process, however, if field personnel deem a robot unsafe, it will not be allowed to practice until the unsafe condition is fixed.
- 10) Robots must pass inspection before actually competing in matches.
- 11) Each time you modify your robot, you must ask the inspectors to re-check your robot.
- 12) Inspectors may re-inspect randomly before or after matches to ensure continued safety and compliance.

3.5.3 Competition Matches

Once a team passes robot inspection, and receives its official inspection sticker, it is eligible to compete.

3.5.3.1 Match Lists:

Before the Pit opens on the morning of the second day, the Pit Administration Supervisor will place copies of the Match List on each team's Pit table. This list includes both days of matches and provides information as to when teams will participate, with whom, and against whom. The list is final and the schedule will not be altered.

3.5.3.2 Scouting:

Teams often use the match list to scout other teams and watch their strategies and robot capabilities. This is especially helpful when choosing alliances, should your team advance to the final rounds.

3.5.3.3 Early Matches:

Make sure your team is on time and in place if you have an early competition on match days.

If your team is scheduled for any of the first four matches on those days, you must queue up before the Opening Ceremony. Matches begin right after its conclusion.

3.5.3.4 Maintaining the Regional Event Schedule

The Pit Announcer and Queue Team will work together throughout the days to line up teams for competition matches and maintain the schedule.

Pay attention to the practice/match schedule and listen for announcements throughout the day. You will need to know when you will compete. Listen for an announcement about the number of the ending match before lunch, and which match designates the end of the competition day.

3.5.3.5 Maintaining Schedule at the Championship

At the Championship, teams are responsible for maintaining the schedule. There will be no audible queuing, and teams must get in queue a half hour prior to each designated match.

3.5.4 **NEW:** Practice Field

Some events will have a field on which teams can practice. If there is one, please adhere to the system in place for its use and use the signup sheet if there is one. Make every effort to keep the area safe, both in and around the perimeter.

3.6 TEAM REGISTRATION

Registration takes place at the Pit at the Administration Station the first morning of the event at the Regionals and Wednesday evening and Thursday morning for the Championship. At each event, *an adult member* of each team must register *by noon on the first day of the event*.

Prior to attending your event(s), please download the General Information Sheet and the Agenda. You can find agendas on the 2007 *FIRST* Robotics Competition Regional Events page.

Please read the following information carefully.

3.6.1 **NEW FORM** - Consent / Release Forms – **NEW Version Required**

You can find the revised form in the “Site Info” for your event at this location.

<http://www.usfirst.org/community/frc/>

Teams cannot register without a completed form for each team member and mentor attending the event(s). This includes adults traveling with the team. The forms for persons under 18 years of age must have a parent or legal guardian’s signature.

3.6.1.1 Prepare and Collect the Forms

Assign someone to take care of this project in advance. *Do not leave it for the last minute!* If a person does not attend the first event and did not turn in a form, he/she must complete one and turn it in at the event he/she attends. This includes the Championship.

We do not want, and will not accept school permission forms in lieu of our official form.

3.6.1.2 Bring Required NEW Forms to Registration

Do not forget these forms. Remember, you need parent signatures for those students under eighteen. By choosing to attend or participate in the 2007 *FIRST* Robotics Competition events, each person grants *FIRST* permission to use all photographs and/or video footage, releases *FIRST* from liability, and provides the opportunity to gather alumni information. Use our consent forms only for this purpose. Treat the Robotics Competition like any other school activity requiring parent/ legal guardian consent. Read below for instructions/requirements:

Team’s <u>INITIAL</u> 2007 Regional Event		Subsequent Regionals & Championship
1.	Download the 2006-07 revised <i>FIRST</i> Consent/ Release form from the website or “Site Info” for your event.	Supply a completed <i>original</i> form only for anyone who has not provided a form at an FRC competition event during this season.
2.	Fill in your team number on the designated line BEFORE you make copies.	
3.	Make enough copies for all team members, mentors, and accompanying adults.	
4.	Have each person fill one out and sign it.	

5.	Team members under 18 must have a parent or legal guardian sign theirs.	
6.	Collect the <i>original</i> forms, clip them together, and bring them to the event.	
7.	Give them to the registration staff at the Pit Administration Station at your initial Regional competition of the season.	

3.6.2 Registration Envelope

Upon receipt of the team's consent/release forms, each team will receive an event-specific registration envelope containing:

- Pit Map:** Pit layout. It shows team location, parts replacement, inspection/ weigh/size areas, the traffic flow, and Pit Administration area.
- Practice Match List:** Schedule designating practice times/alliance partners for all teams on the first day of the event.
- Safety Captain Badge:** This safety badge is in the team's initial event registration envelope.
- 10 Safety Tokens:** These tokens are part of our safety recognition program.
- Team List:** List of competing teams by number, official team name, and state.
- 4 Operator Badges:** These are for the 2 operators, 1 human player, and 1 coach/mentor. The badge with the dot is the mentor's. *He or she cannot score points or operate the robot.*

3.7 THE PIT

Teams spend a lot of time in the Pit working on their robots. It also houses the Replacement Parts area and the inspection station. It is important to use thoughtful manners and true team spirit here since quarters are equal, but often cramped.

Get to know other teams, help each other when you can, and keep the aisles clear. Time is short, and help is very often right "next door" in the adjacent Pit stations.

3.7.1 Be Safe, Be Kind, Be Gracious

- Use common sense regarding safety and courtesy.
- Read and follow the "Courtesies and Rules List" section. Print, provide, and discuss them with all team members and mentors.
- Wear required ANSI-approved, non-shaded safety glasses in the team Stations at all times.
- Wear required ANSI-approved safety glasses when working on or watching work done on a robot. Wear them on the playing field.
- Choose a student or adult Safety Captain during the build season to monitor team safety at your work areas and also at the events.
- Take advice from Safety Captains and Safety Advisors.

3.7.2 Administration Station

The Pit Administration Station is centrally located in the Pit area. *FIRST* staff members and/or volunteers run this area to register teams and help teams and visitors. Come to the Pit Administration station to:

- Turn in your team's Consent/Release Forms.
- Register and receive your registration envelope and badges. Check your event agenda for the Pit opening/closing time for each event.
- Notify a staff member that your team is ready for its initial robot inspection.
- Pick up participation medallions at your initial event of the season.
- Look at an FRC Competition Manual.
- Obtain initial safety tokens and turn them in for the award count.
- Get answers to most questions, including machine shop access.
- Ask about lost and found articles.
- Report an illness or injury.

3.7.3 Pit Map

You will receive a Pit map when you register. It shows team locations, robot traffic flow, First Aid/EMT Station, Replacement Parts Area, Inspection Area, and the Pit Administration Station.

3.7.4 NEW: Team Stations

These are the spaces where teams work on their robots. These numbered spaces help organize team placement and help team members, judges, and visitors find teams easily. These areas are set up to be as equal as possible. Each team's pit station will have a table and power outlet.

3.7.4.1 **NEW:** Rules

For safety and because of insurance regulations:

- Teams cannot build any structure that supports people, or items for storage, above the work area in their team pit station.
- No Team Station structures, signs, flags, or displays can be higher than 10 feet above the floor.
- Team Station signs, flags, and displays must be securely mounted to the structure.
- *FIRST* personnel, event management, and/or local committee members will require teams to remove any pit structure that is deemed unsafe or outside specifications.

3.7.4.2 Station Numbering/Signage

Each team station will already be set up with its team number on a pole. The mounted signs are aligned for easy team identification and are reused at other events. Do not alter them or remove them, as this will be considered stealing.

3.7.4.3 Space Regulations

Each team is allotted approximately the same amount of workspace, usually about 10' by 10' feet; however, the size may vary from event to event. Be sure your equipment will fit in a space smaller than those dimensions.

It is not gracious to expand your area. Keep your equipment and team members within this area and do not "grow" into the aisle or undesignated space. If your team is too large to fit into the allotted space, encourage your team to leave the area to scout other teams and/or watch the matches.

Don't add to your space by setting up in another Pit area or by adding illegal height.

3.7.5 Aisles

It is extremely important to keep aisles clear for safety, judging accessibility, robot mobility, courtesy, and maintaining competition schedules. Keep chairs and equipment out of the aisles. Please sit in the audience, not on the floor or in the aisles. Judges/Safety Advisors will notice noncompliance.

3.7.6 Suggested Equipment

We suggest you bring the following:

- Extension cord, heavy duty and at least 25 feet long.
- Power strip to make best use of your power drop.
- Other items as suggested on the *Team Checklist* in this section of this Manual.
- A relatively small cart to transport your heavy robot from the Pit to the playing field. Do not add music to your cart.

3.7.7 Replacement Kit Parts Availability at Events

Spare parts will be available at the events; however, the available parts at the events will not be published until after Kickoff. Watch for a Team Update with this information after the Kickoff.

FIRST asks that teams bring any unused parts from their kits to events to assist and support each other. This kindness can expand your *FIRST* network of friends as you exchange parts.

Batteries & chargers will NOT be available at any event unless you have made prior arrangements with FIRST.

3.7.8 Control Systems

Teams are responsible for all Innovation First, Inc. products required at events. If a team has a problem with its controller, LOANERS will be available under the following restrictions:

- Teams must get approval from the on-site Innovation First, Inc. staff member.
- An adult member of the team must provide a Credit Card number to ensure proper return of the items after the completion of the event.
- ***If the part is not returned at the end of the event, or the part is damaged when returned, FIRST will bill the credit card for the replacement cost of the borrowed item or the repair charge.***
- All "loaner" items are available on a first-come, first-served basis. **(*) Requires approval from Innovation First, Inc. before a team can borrow equipment.**
- Operator Interface (*)
- Robot Controller (*)
- Radio Modems (*)
- AC Adapter for Operator Interface
- Speed Controllers (Victor 884)
- Relay Modules (Spike)

3.7.9 Machine Shop

Each event has a machine shop to help teams with repair and fabrication. While the machine shops vary from event to event, *FIRST* strives to have welding and a variety of high-powered

tools available at the shop. Grinding and tools that cause sparks are not allowed in the Pit, so teams must use the machine shop for repairs requiring these "fixes."

The staff and volunteers in the Pit Administration Station will be able to tell you how the system works. Sometimes the machine shop is on site and readily accessible to all teams, but when it is off site, we require teams to use the mandatory transportation provided at the venue. *Teams cannot travel to the machine shop "on their own."*

3.7.10 Announcer

Each Regional event has a Pit announcer to coordinate the queuing (lining up) of teams to the practice or competition lineups. We make every effort to keep noise down and announce only important items and scheduling, so do not ask her/him to make frivolous announcements.

3.7.11 Robot Traffic Flow

There is a pre-determined traffic flow pattern to maximize efficiency of the team/robot ingress and egress and maintain safe competition areas. Refer to the Pit Map for the flow. The queuing team maintains this pattern at each event. Please obey the traffic rules to ensure an efficient lineup for practice and competition.

3.7.12 Queuing

The Pit announcer and queue volunteers must maintain the practice and match schedules. Your team should designate team members to be your queue captains and carefully watch the schedule and alert the team when its turn is near. The queue captain should:

- Look at the Pit Map to find the pre-set traffic pattern for each event.
- Highlight team practice times on the Practice Schedule on the first day of the event and your competition match times on your Match List for the second and third days.
- Listen carefully for the queuing announcements at Regional events and line up your four (4) competing team members/mentor and robot when your team number is announced.
- Queue your team a half hour prior to your matches at the Championship since there are no match announcements. Ensure that you monitor play within your respective division and adjust your queuing time accordingly. Please check with the Lead Field Queuing personnel on your field if you have questions.

NOTE: *Check the second and third day schedule. If your team is in the first 4 matches of either day, the competition team must queue up prior to the Opening Ceremony, on or near the field.*

3.7.13 Property Security

There have been occasions when items such as cameras and laptops have "disappeared" from the Pit or competition area. Use common sense and do not leave such valuable items unattended. Neither the site nor *FIRST* is responsible for any theft. Take valuable items with you, or designate a team representative to remain with the items in the Pit Station or competition areas.

3.7.14 Lost and Found

If you find an article or lose one, come to the Pit Administration Table to fill out a "Lost Item Report," or to turn in an article you find. We try hard to return articles to owners.

3.7.15 First Aid

There will be an EMT or Nurse in the Pit to assist with injury and illness. Mentors and the Safety Captain should refer to the Pit Map for the location and alert team members. *Notify the Pit Administration Supervisor of any injuries or illness.* Bring box of bandages for minor injuries.

3.8 OPENING AND AWARDS CEREMONIES

There are both Opening and Awards Ceremonies on the second and third day at Regional events. These ceremonies allow everyone to show honor and respect for our country, sponsors, teams, mentors, volunteers, and award winners and to provide everyone with the opportunity to applaud the successes of team members. They also give teams a chance to "meet" the judges, referees, and important persons and sponsors involved with the event.

At the Awards Ceremony, **FIRST** presents trophies and medallions to outstanding teams.

3.8.1 All Teams Should Attend

We encourage all team members to attend the ceremonies, on time, to show appreciation for the event and those people involved who are volunteering their time and efforts.

3.8.2 Pit Manners/Rules During the Ceremonies

- 13) Team members will *not* be allowed to use power tools, hammers, or other noisy tools during the ceremonies.
- 14) All persons in the Pit should observe the code of behavior for the presentation of the *Star Spangled Banner* and any and all national anthems:
 - Maintain a respectful silence.
 - Stand, facing the flag. If there is no flag, look toward the video screen showing a flag.
 - Hats off, please.

3.8.3 **NEW:** Pit Closing Etiquette

For many reasons, it is necessary that teams adhere to the Pit closing time each day. Many people working in the Pit are volunteers and deserve to have a set closing time met. Assign team members and mentors to the clean up/organization of your pit station.

The mentor in charge of your robot shipment must take care of the shipping process early with a plan in place to have everything packed and out the door by closing time. This means having a crew ready to get your robot crated and labeled for shipment on the last day. When your play in the competition ends, pack your crate; notify the shipping/drayage company that it is available for removal and clean up your area. It is not gracious to the Pit staff or the drayage company to leave these details to the last minute.

This advance preparation also applies to teams in the event finals, especially at the Championship. The shipping and exit process for the Championship is huge. People are tired. Do your part.

3.9 TEAM SOCIALS

The team social is a great part of the competition celebration. Refer to the website to see if your event has one <http://www.usfirst.org/community/frc/regionalevents>. They are usually after the Awards Ceremony on the evening of the second day, and usually include food, fun, and an opportunity to unwind and get to know each other in an informal, relaxed, and entertaining setting.

3.9.1 Requirements

In order to help ensure that your team social will be organized and fun, each attending team must have 1 responsible, adult chaperone for each 10 students. All team members and mentors must conduct themselves respectfully.

3.9.2 Regional Socials

Check the Regional Events section on the website for dates and location for this activity at <http://www.usfirst.org/community/frc/>

There usually is no charge, and "come as you are from the competition" is the dress code. Remember that your behavior reflects the ethics of your team and sets the tone for the activities. We expect the best from our teams because they are the best!

3.9.3 Championship *FIRST* Finale

This event takes place after the Awards Ceremony on Saturday evening. Please refer to the *Championship* event Information.

3.10 PARTICIPATION MEDALLIONS

FIRST provides ONE box of twenty-five (25) bronze medallions to each team that has *not* won medals as a:

- A Regional Chairman's Award winner
- An Engineering Inspiration Award winner
- A 2007 Regional Champion or Regional Finalist

3.10.1 One-Time Pickup at Team's Initial Event

A box of 25 medallions is given out at the Pit Admin Station at each team's initial event only. Pick up/sign for them on the last day of the event, once it's clear that you won't receive any of the awards listed above. If your team has been to another event, you will **not** receive medallions at a subsequent event. See below.

3.10.2 If You Forget to Pick Up Your Medallions

- Teams have to request shipment.
- Teams will pay for the shipment cost via their shipping account number in the TIMS.
- The medallions will not ship until after our trucks return from the Championship and materials are unloaded and categorized. Estimated ship time would be mid/end May.
- We will accept check, credit card, or money order. We will not accept purchase orders, and there will be a request deadline.

3.11 TEAM SPIRIT AND STYL'N

When deciding on a team name or acronym, consider how you can work a theme around it to make your team more fun and recognizable. Competing as a team is fun and rewarding. Part of the pleasure of being a team member or mentor is the way the team stylizes itself with team T-shirts, trading buttons, hats, cheers, and costumes.

3.11.1 Mascots and Team Costumes

Keep safety in mind. Awards acceptance often means descending and ascending bleachers. Please make sure that mascot and team costumes are safe for the wearer as to vision and movement and that they are comfortable and cool enough to prevent fainting and dehydration.

3.11.2 Competition Spirit

We ask that you choose to bring attention to your team in ways that are in good taste and in the spirit of the competition. Please refrain from the following:

- Using obnoxious noisemakers.
- Using objects that can damage bleachers or floors.
- Taping or affixing items or papers to walls, bleachers, floors, or other site areas.

Please make sure your Pit Station and surrounding area is clean when you leave the site.

3.11.3 Banners and Flags - Rules

Sponsors provide *FIRST* with banners so we can display them in specified areas as a way of thanking them for their generosity. We encourage teams to bring team flags and/or sponsor banners, but we ask that you adhere to the following:

- Do not hang them in the competition area, since this area is designated for official *FIRST* sponsors' banners.
- You may bring banners to the competition area while your team competes, but do not leave them or use them to section off seating. Saving group seats is not permitted.
- Hang banners in your Pit station only, not on the Pit walls.

3.11.4 Saving Seats Not Allowed

Sitting together in a group during competition rounds makes the game more exciting and fun. It's where you can show support for your team. Since very often there is not enough seating to accommodate everyone, there has to be a policy regarding seating, so teams are not allowed to save seating space.

With this in mind, it is not gracious or fair to hang banners or ribbons to designate such an area. *We will remove and discard banners or roping, etc.* Please take turns sitting in the bleachers. Share the fun. When you see there is a crowding problem, leave after your team's match and return later for another few rounds.

3.12 SITE RESTRICTIONS

Please read the following restrictions and adhere to them in order to promote an orderly, safe, pleasant, and exciting competition. As a group, we all should honor agreements with the venue and help promote the spirit of good partnership. **Please:**

- **Do not bring food** on the site. If you bring food, do not bring it onto the property.
- **Do not use noisy devices**, such as floor stompers, whistles, or air horns.
- **Do not save seats.** It is not fair to other teams or the public we hope to interest as team sponsors/volunteers.
- **Do not deliver or ship robots directly to the competition site.** All shipments go through the drayage company.
- **Do not arrange for Internet access** on the site or attempt to connect to the Internet.
- **Do not sell any products.** This includes food, hats, shirts, or any promotional products.
- **Do not give out any free food products**, such as candy, water, soft drinks, or fruit. You may trade team pins, however.
- **Do not sell raffle tickets.**
- **Do not remove any *FIRST* or Team number signs.** *This is stealing!* We use signs for multi-event and multi-year applications.
- **Do not bring helium tanks.** This is a safety concern.
- **Do not use walkie-talkies.** They can interfere with the robots.
- **Do not invite or bring live bands** to play in the audience. This dilutes the presentation on the playing field and is too loud and confusing for the audience.
- **Do not play loud music in the Pit** because it interferes with important announcements. If a team receives more than a warning or two, the power to the team's Pit Station will be shut off and/or the music confiscated.

- **Do not form "tunnels"** during the Awards Ceremony. This can cause discomfort to those traveling through them and creates safety issues.
- **Do not run in the venue.** This is an obvious safety concern/violation.
- **Do not wear open-toed shoes.** This is a safety concern.

3.13 COURTESIES AND RULES

The behind-the-scenes action is in the Pit. This is where you can get to know other team members and perhaps pick a few brains and learn a few things. The *FIRST* Staff and volunteers want you to enjoy the competition and ask that everyone follow courtesy rules while in the Pit, on the playing field, and in the audience.

We are trying to encourage support from our audience members at the Regional events and the Championship because we need continued and growing support from outside sources. Please help to make guests feel comfortable and welcome. Provide your team with the site restrictions and rules so everyone can work and compete in a safe, sportsmanlike, friendly, and orderly environment.

3.14 CONSIDERATIONS

You will often hear the expression *Gracious Professionalism* throughout your involvement in *FIRST*. You can read Woodie Flowers' definition in the "Introduction" portion of the Manual. One of our main goals is to encourage all team members and mentors to conduct themselves with kindness, consideration, and sharing.

We hear heartwarming stories of teams sharing parts, helping to build and/or repair competing robots, and helping rookie teams avoid preventable pitfalls. These are examples of some side benefits of being involved with this organization. Please read the following sections to help further the success of *FIRST* and its teams.

3.14.1 Donated Software Use/Restrictions

Software companies donate software to *FIRST* teams, and we consider it as part of the Kit of Parts. They provide it with the understanding that the teams will read the licensing agreement and comply with their rules. *The donated software is for team use and is not donated for use by the school.*

Think about which computer will be the most convenient and appropriate for team use. Be sure to check the number of allowed installations for each application. It is illegal to install software on more than the stipulated installation number.

3.14.2 Sharing Fundraising Ideas

There is some very unique fundraising going on within *FIRST* teams. If your team has any ideas to share and help other teams:

- 1) Make sure you document them in your Chairman's Award submission.
- 2) Please e-mail your ideas to <mailto:frcteams@usfirst.org> so fellow teams can share your innovations in profitability. This is a way of building on and expanding Gracious Professionalism.
- 3) Please realize that fundraising is not allowed at competition events.

3.14.3 Pit and Competition Safety

Battery Safety: (Sealed Acid Lead)	Charge in an open, well-ventilated area. Do not charge near an open flame or near equipment that may produce sparks. Do not use smoking materials in the battery charging area. Charge in an upright position. It is not safe to charge the SAL battery in an inverted position. Should your battery leak, ask the Pit Administration Supervisor for baking soda to absorb the acid.
Brazing/Welding:	Prohibited at the pit stations. Use the machine shop.
Fire Extinguishers:	Located at the Pit Admin. Station and near the Playing Field.
Grinding/Painting:	No grinding or painting in the Pit. Designated grinding and painting areas are available to teams.
Open Flames:	No open flames are allowed in the buildings.
Pit Station Crowding:	Please stay within your Pit Station or move to the competition viewing area. If the pit area becomes too crowded for teams and their machines to move back and forth to the field safely and quickly, <i>FIRST</i> will request that some team members leave the area.
Robot Loading in/out:	For safety and accountability, only the drayage company handles loading in and out of robots.
Robot Operation:	Operate robots on tether only in Pit area.
Running:	No running in the venue
Safety Captain	Each team appoints a Safety Captain who will help maintain event safety, especially in the Pit. He/she should monitor your team's general safety practices and Pit and Pit Station safety.
Safety glasses (Approved):	All team members and onlookers must wear safety glasses in the Pit and when working on a robot or observing same. They are also required on the playing field. If you wear glasses, you must wear safety goggles over them." Teams must bring enough safety glasses/goggles for mentors, team members, and guests.
NEW - Soldering:	Soldering is permitted using electric iron/gun only.
Two-way radios:	Not allowed in the Pit or near the playing field since they may interfere with robot operation and cause accidents.

3.14.4 Courtesy and Site Regulations

Bands or Drum Units:	No live bands in the audience or Pit.
Food:	You cannot bring food on site at all. Not even as a promotion. Do not provide teams with candy, water, fruit, soft drinks, etc. This is to promote good will and the spirit of partnership with the venues
Music/Noise:	No loud music, audio systems, whistles, banging sticks, blow horns, etc. They interfere with announcements, prevent teams from hearing important announcements, can be annoying, and can cause hearing loss. Offending team's power may be shut off and/or radio, cd player, or noise makers confiscated.

Phone lines:	No free phone lines for internet access.....at all.
Pit/Machine Shop Hours:	Specific hours are necessary to provide teams with equal work time. Please be aware of the opening and closing hours of the Pit and Machine Shop posted on the agenda you receive in your Registration envelope.
Selling items at the event:	Because of site regulations/contracts, <i>FIRST</i> cannot allow teams or individuals to sell items, such as T-shirts, pins, etc., at any events.

3.15 LOCAL STORES - WEBSITES

Use these URLs to locate stores in the vicinity of your hotel and/or competition site. Before you travel, print out directions from both the competition site and your hotel. Competition site addresses for each event are on our website in the Events Sections, "Site Info."

Note for Canada: Please note that the website addresses for stores in Canada end in ".ca".

If the address is for a home page, click on the "find a store," "store locator," or "location."

HARDWARE STORES	
Ace Hardware	http://www.acehardware.com/
Lowe's	http://www.lowes.com/
Menard's	http://www.menards.com/nindex.jsp
The Home Depot	http://www.homedepot.com/home.html
The Home Depot Canada	www.homedepot.ca
True Value Hardware	http://www.truevalue.com/

OFFICE SUPPLIES	
Kinko's	http://www.fedex.com/us/officeprint/main/index.html/
Office Depot	http://www.officedepot.com/
Office Max	http://www.officemax.com/
Staples	http://www.staples.com/about/store/find/
Staples Business Depot	www.staples.ca

VARIETY STORES	
Kmart	http://www.bluelight.com/home/index.jsp
Target	http://sites.target.com/site/en/spot/page.jsp?title=stores_services_main
Wal*Mart	http://www.walmart.com/cservice/ca_storefinder.gsp?NavMode=7

ELECTRONICS

Best Buy: <http://www.bestbuy.com/>
Circuit City: <http://www.circuitcity.com/>
Future Shop www.futureshop.ca
Radio Shack®: <http://www.radioshack.com/>

DRUG STORES

CVS Pharmacy <http://www.cvs.com/CVSAApp/cvs/gateway/cvsmain>
Eckerd <http://www2.eckerd.com/Default.asp>
Rite Aid <http://www.riteaid.com/stores/locator/>
Sav-On <http://www.savon.com/default2.asp>
Shoppers Drug Mart www.shoppersdrugmart.ca
Walgreens <http://www.walgreens.com/>

3.16 HOT REMINDERS AS YOU PACK

SAFETY GLASSES

**NEW: SAFETY GLASSES are
REQUIRED IN ALL AREAS OF THE PIT!
EVERYONE WILL NEED A PAIR TO
ENTER THE PIT.**

**Bring enough for your team, visitors,
and those uncrating the robot.**

CONSENT FORMS

**Bring required completed
CONSENT/ RELEASE FORMS for
all team members and mentors!**

3.16.1 Packing; Team Checklist

This list suggests items your team may want to / must bring. Replenish between events.

TOOL BOX ITEMS	ADDITIONAL ITEMS
<ul style="list-style-type: none"> -- Adjustable crescent wrench -- Allen wrenches -- Ball driver set / Nut driver set -- Batteries and Charger -- Box cutter -- C-Clamp, large, medium, small -- Cutters -- De-burring tool -- Dremel tool/accessories -- Drill bit set -- Drill - cordless w/charger -- Duct tape -- Electrical tape -- Flashlight -- Flat and Phillips Screwdriver assortment -- Hacksaw and blades -- Hammer (ball peen & brass) -- Heat gun -- "Leatherman" tool -- Level, small -- Lithium grease, spray can -- Lock tight -- Magnet on a stick -- Needle nose pliers - medium, small -- Open end and boxed end wrenches -- Paint brush -- Pliers, - large, small -- Power Outlet Strip / Extension cord (2) -- Power Screwdriver -- Saber Saw/wood & metal blades -- Sandpaper - various grits -- Screws - nuts - washers -- Shrink tubing -- Socket set - 1/4", 3/8" drive -- Soldering iron, solder, solder wick, flux -- Spare parts -- Super glue / stick glue -- Square - small, medium -- Tap & die set/assorted taps -- Tape: Clear / masking / duct -- Tape measure / ruler -- Tie Wraps / Connectors -- Tin snips -- Tweezers / scissors -- Vice grip - large, small -- Volt meter -- WD-40 / Lithium grease, spray can -- Wire terminal crimpers / Wire strippers -- Work Gloves- several pairs -- X-Acto knife and blades 	<ul style="list-style-type: none"> -- Banners - Corporate signs & flags for Pit Station -- Cart for robot -- Clock -- Dirt Devil - vacuum -- Disposable camera / extra film -- Drop light -- Epoxy -- File folder box for paperwork -- Hand truck -- Laptop / software / cables / discs -- Manual and Updates -- Medical Release Forms -- Message Board - dry erase marker set -- Notepads / spiral notebook / clipboard -- Paper / Post It Notes -- Paper towels and paper cups -- Pens / pencils / sharpies / markers -- Pit station monitor / clean up schedule -- Portable printer -- Registration Papers - completed release forms -- Rubber bands -- Schedule to set up and break down pit station -- Small broom -- Small foldable seats for Pit Station -- Small trash can, trash bags -- Spray cleaner -- Stapler / staples -- Storage box - trinkets & trash (buttons) -- Team roster -- Upright storage bins -- Water cooler / cups or water bottles -- Ziploc bags -- ESSENTIALS/PERSONALS -- 1st Aid Kit -- Advil / Aspirin / Tylenol -- Alcohol Prep Pads / 3M First Aid tape -- Band-Aids / Blister kit / Ice Bag -- Cough drops / sore throat medicine -- Extra - toothbrushes / hairbrushes / combs -- Extra - travel size deodorant/razors -- Eye wash and drops -- Hand sanitizer / Liquid Soap -- Feminine products -- Insect sting medicine / OFF spray -- Kleenex / Cotton Balls / Wet ones / Q-Tips -- Neosporin -- Pepto-Bismol / Imodium AD -- Small Sewing Kit -- Sunscreen / Sunburn Spray / Aloe Vera

Section
4

ROBOT TRANSPORTATION



TABLE OF CONTENTS

- 4 ROBOT TRANSPORTATION3**
- 4.1. OVERVIEW 3
- 4.2. BATTERY PACKAGING..... 3
- 4.3. CRATE INFORMATION 4
 - 4.3.1. NEW* Crate Construction Specifications 4
 - 4.3.2. Crate Limit..... 4
 - 4.3.3. Crate Labeling 5
 - 4.3.4. Required Crate Contents..... 5
- 4.4. ROBOTS SHIPPING ACROSS A U.S. BORDER 5
 - 4.4.1. Wood packaging laws/restrictions..... 5
 - 4.4.2. Exemptions 6
 - 4.4.3. Related Web sites 6
 - 4.4.4. Rules..... 6
- 4.5. INTERNATIONAL SHIPMENTS AND CUSTOMS 6
- 4.6. SHIPPING AND DRAYAGE DEFINITIONS 6
- 4.7. VISUAL DEPICTION OF SHIPPING / DRAYAGE PROCESS 8
- 4.8. SHIPPING YOUR ROBOT 9
 - 4.8.1. Teams have two shipping carrier options from event to event: 9
 - 4.8.2. Shipping to Your Initial Event..... 9
 - 4.8.3. Crate Shipment Deadline and Requirement 9
 - 4.8.4. Delivery Stipulations for Drayage Terminal and Delivery Vehicle..... 10
 - 4.8.5. Mandatory - Initial Crate(s) Shipment Verification Process 10
 - 4.8.6. Verification Mailing Address – Use capitals please..... 10
 - 4.8.7. Robots Must Ship from Event to Event 11
 - 4.8.8. Delivery Deadlines 11
- 4.9. FEDEX® EXPRESS FREIGHT SYSTEM COMPLIMENTARY SHIPPING 11
 - 4.9.1. The FedEx Express Freight Donation..... 11
 - 4.9.2. Teams in the 48 Contiguous U.S. States..... 12
 - 4.9.3. Process – Teams in HI, AK, PR..... 13
 - 4.9.4. Process – International Teams Competing in the U.S..... 13
 - 4.9.5. Weigh the Donation Value..... 13
 - 4.9.6. Additional FedEx Important Notes 13

4.9.7.	FedEx Weight Limit	14
4.9.8.	Shipment Insurance	14
4.9.9.	International / Unusual Shipments.....	14
4.9.10.	NEW: The FedEx Shipping Administration System (formerly Passkey).....	15
4.9.11.	Printing the airbill	15
4.9.12.	Using the airbill	15
4.10.	ROADWAY, INC. QUOTES	16
4.11.	TRACK YOUR CRATE	17
4.12.	DRAYAGE	17
4.12.1.	The Drayage Companies: Functions and Services.....	17
4.12.2.	Drayage Company Regulations	18
4.12.3.	Freight Overage.....	18
4.12.4.	Immediate On-site Crate Weight Complaint Resolution, 7:45a.m.-8:30a.m.....	18
4.12.5.	Weight and Rates Structure	19
4.12.6.	Outbound Shipments from the Drayage Terminal	19
4.12.7.	Example of SES Outbound Bill of Lading.....	21
4.13.	WE JUST QUALIFIED FOR THE CHAMPIONSHIP.....	22
4.13.1.	What do we do? Is there a Decision Deadline?.....	22
4.13.2.	Undecided? Temporary Crate Shipment “Hold, Then Ship”	22
4.13.3.	We Changed our Minds	22

4 ROBOT TRANSPORTATION

4.1. OVERVIEW

This section provides information regarding crate specifications, shipping, and associated requirements, the drayage system, and the FedEx® Freight shipping donation requirements and caveats. Please make sure those persons responsible for building and shipping your team's crate(s) understand and follow the guidelines for these processes. Adherence to these processes is key to a successful season.

Read the sections below that describe the specific, federally regulated battery packaging method and the regulations for wood packaging coming into the U.S.

4.2. BATTERY PACKAGING

When shipping the 12VDC Batteries in the crate together with the robot, Federal regulations require teams to follow the instructions below. If you do not adhere to these rules, your crate may not make it to the event(s).

Each time you ship your robot, you must:

- Ship the two (2) Kit of Parts 12VDC batteries inside their original box or carton packaging. Additional batteries can be shipped or brought with you.
- Use the Styrofoam covering with protective caps to cover the battery terminals.
- Secure the boxed batteries inside the "inner battery box" section of the robot crate in an upright position. *The photograph below shows a sample of an inner battery box built to comply with regulations.* Remember to label this box...see below.



- 1) **ABSOLUTELY NO** batteries are to remain mounted (connected or disconnected) on the robot!
- 2) Use the battery labels provided in the web site Events area, "Shipping / Drayage" section. Each crate **MUST** be marked "**NON-SPILLABLE BATTERY**" in 1" or larger letters on all four facing sides.
- 3) Mark the inner battery box with the battery labels also. It too **MUST** be marked "**NON-SPILLABLE BATTERY**" in 1" or larger letters on 2 sides of the battery box.

4.3. CRATE INFORMATION

Build your crate so it is sturdy and falls within height and weight specifications when packed for shipment. Be sure to adhere to crate specifications. The Drayage Company determines whether a crate meets the size and weight criteria and will pass non-conforming crate information to *FIRST*.

If a crate exceeds size specifications, or the crate is poorly constructed, *FIRST* will not guarantee its security or delivery to the site. The Drayage Company will round up to the next hundredweight if a crate exceeds 400 pounds, and will charge accordingly. For specific information, refer to the *FIRST* Web site and choose your event area, then "Shipping / Drayage" <http://www.usfirst.org/community/frc/>

4.3.1. **NEW*** Crate Construction Specifications

Build your crate(s) with more than one shipment and season in mind. Remember to consider the weight of your materials. For instance, if 3/8" or 1/2" plywood is sturdy enough, why use the much heavier, costlier 3/4" product?

All Crates must:

- 1) Comply with the "Wood Materials Regulations Across U.S. Borders" section below if the crate ships into the U.S.
- 2) Loaded crate must weigh 400 pounds or less in order to avoid drayage overage charges
- 3) Be sturdily built to prevent damage to your equipment
- 4) ***Use** 3/8" or 1/2" plywood
- 5) ***Use** 3/8" or 1/2" Oriented Strand Board (OSB), a solid panel product of consistent quality with no laps, gaps, or voids.
- 6) ***Medium density fiberboard (MDF) is **Not recommended**** for crate building because the material makes crate construction too heavy, and MDF can be dangerous to use if the correct safety precautions are not taken. MDF contains a substance called urea formaldehyde, which may be released from the material through cutting and sanding and cause irritation to the eyes and lungs.
- 7) ***Don't use** particleboard because it collects moisture that adds weight and may cause the crate to fall apart. Remember, your crate may be exposed to the elements when loading and unloading trucks.
- 8) Ensure your crate construction can withstand stacking during transport
- 9) "Sit" on 2 pieces of 4" by 4" lumber, spaced at least 28" apart so it can be moved by a forklift.
- 10) Have a footprint no greater than 4' by 4' and be no taller than 5'10" (70") high. This maximum includes the 4" by 4" lumber mentioned above.

4.3.2. **Crate Limit**

FIRST asks that each team ship only one crate, **but mandates a maximum of two crates for any team at any competition site**. This helps keep Pit entrances, aisles, and egresses clear, safe, and less crowded. This restriction also keeps team costs down.

If you ship an extra crate, it must also meet the above specifications. *Teams pay all shipping and drayage costs for the additional crate.*

4.3.3. Crate Labeling

- 1) Go to the web site <http://www.usfirst.org/community/frc/content.aspx?id=430> or to the Championship Event web area:
- 2) Obtain the printable, mandatory address label for your event's drayage terminal from the "Shipping / Drayage" area.
- 3) Fill in your team number and team information on the address label; make an additional 3 copies and attach one to each side of the 4 facing sides of the crate. Repeat this for each event you will attend. This label helps the shipper and also helps the drayage company easily locate your crate at the warehouse and competition sites.
- 4) Print the battery label, make 5 additional copies, and tape one to each facing side of the crate. Remember to label 2 sides of the battery box inside as well.
- 5) Place a clear airbill sleeve on your crate and insert the shipping label.
- 6) Bring your outbound labels to the event for the next crate shipment.
- 7) Bring extra airbill sleeves in case yours get damaged during shipment

4.3.4. **NEW:** Required Crate Contents

Teams must include:

- the Robot
- the Operator Console
 - See section 8 for definition of Operator Console
 - If you use a computer as part of the Console, you do not have to ship the computer, but may not continue to program your dashboard
- the two (2) Kit of Parts 12VDC batteries

Please pack per "Battery Packaging" section above.

- 1) **Non-North American teams cannot ship batteries with their crate(s).** They must make arrangements with *FIRST* to pick up a battery for competition at their initial event.)
- 2) SAFETY NOTE: Don't pack all of your safety glasses in your crate. You will need them when uncrating!

4.4. ROBOTS SHIPPING ACROSS A U.S. BORDER

The sections above apply to all crates. Crates crossing a U.S. border have additional limits, and additional information is provided below.

New Federal Rules apply to the crating and pallets you will use to ship crates across U.S. Borders to FRC events. Please read the sections below.

4.4.1. Wood packaging laws/restrictions

The following regulation applies to any team planning to ship its robot into the U.S. from another country. Teams that do not comply risk having their robots detained at the U.S. border by U.S. Customs and not shipping to the event on time.

The U.S. Dept. of Agriculture has adopted new international guidelines to decrease the potential for the introduction of certain plant pests that may accompany wood materials arriving from other countries. These guidelines call for wood packing materials used in the construction of crates and pallets to be either heat treated or fumigated with methyl bromide in accordance with applicable

rules. These wood materials must be marked with an approved international mark certifying that treatment. The final rule became effective in September 2005, and affects all persons using wood packaging material in connection with importing goods into the U. S.

4.4.2. Exemptions

The following exemptions apply to the above wood packing material rules:

- Processed wood packing materials that have received more than primary processing, e.g., plywood, corrugated board, fiberboard, veneer, whiskey and wine barrels, strand board, etc.
- Pieces of wood less than 6 mm/0.24 inches in any dimension
- Loose wood packing material such as shavings, excelsior, etc.
- Wood packing material originating in Canada and made in Canada (an importer's statement may be required to document the origin of the wood packing material)

4.4.3. Related Web sites

3) Refer to http://www.cbp.gov/xp/cgov/import/commercial_enforcement/ for specific information on the recent stages of implementation. This site has:

- * Examples of the regulatory stamps.
- * A Questions and Answers section for clarification.

4) Contact your local FedEx office for additional information and assistance. You can also find information at: <http://fedex.com/us/promo/woodpackaging.html>

4.4.4. Rules

FIRST recommends that all international teams, or U.S. teams shipping out of the U.S. and then back into the Country, do the following:

- Use only plywood or other exempted wood materials when constructing their shipping crates and robots.
- If using raw wood materials such as 4"x4", 2"x4"s, 1"x boards, etc., obtain the materials from a lumber dealer who sells compliant wood products.
- Be sure the wood is marked with the approved international mark.
- Make sure you use properly treated and labeled wood for the 4" x 4"s under your crate used for facilitating forklift use.
- If you must use a pallet to ship your crate, make sure the pallet is either non-wood or a compliant wood pallet. Compliant pallets are available from commercial pallet distributors.

Canadian teams should obtain an appropriate importer's statement as indicated.

4.5. INTERNATIONAL SHIPMENTS AND CUSTOMS

- Teams shipping to the Canadian Regional and international teams shipping into the U.S. and back should research Customs requirements weeks in advance.
- *FIRST* strongly recommends using a Customs Broker so your team knows exactly what paperwork it needs to import and export your crate.
- Comply with the Building Restrictions/Laws Regarding Wood Materials listed in above sections.

4.6. SHIPPING AND DRAYAGE DEFINITIONS

At Drayage Deadline Latest date and time you can have your robot delivered to drayage facility.
Note: This deadline ensures machines arrive at drayage in time for competition site delivery.

Bill of Lading (Material Handling Form) This is a receipt Shepard Exposition Services (SES) requires you to fill out in order to keep track of your crate(s), whether you ship FedEx or the designated carrier, Roadway. You will receive a copy to help you track your crate.

Drayage In our case, drayage refers to the system of accepting the delivered crate(s) into the drayage terminal, the crate storage, crate delivery to the event site, then back to the drayage terminal.

Drayage Companies Temporary warehousing companies. They take in, store, deliver, and document movement of event materials. In our case, the Drayage Company receives and documents team crate weight and arrival time, then stores them until delivery to the event site Pit Stations on the day prior to the event.

Ship Deadline The robot crate must leave the team's possession by delivering it or shipping it to the drayage facility. This deadline helps ensure that teams have equal robot work time.

Shipping In this case, the term "shipping" refers to the transportation of your crate(s):

- To the Drayage (material handling) Company
- From the Drayage facility/warehouse to the next event's Drayage facility
- Home after your last event

4.7. VISUAL DEPICTION OF SHIPPING / DRAYAGE PROCESS

Please take a look at the figure below. It provides a visual of the flow of a team's crate shipment.

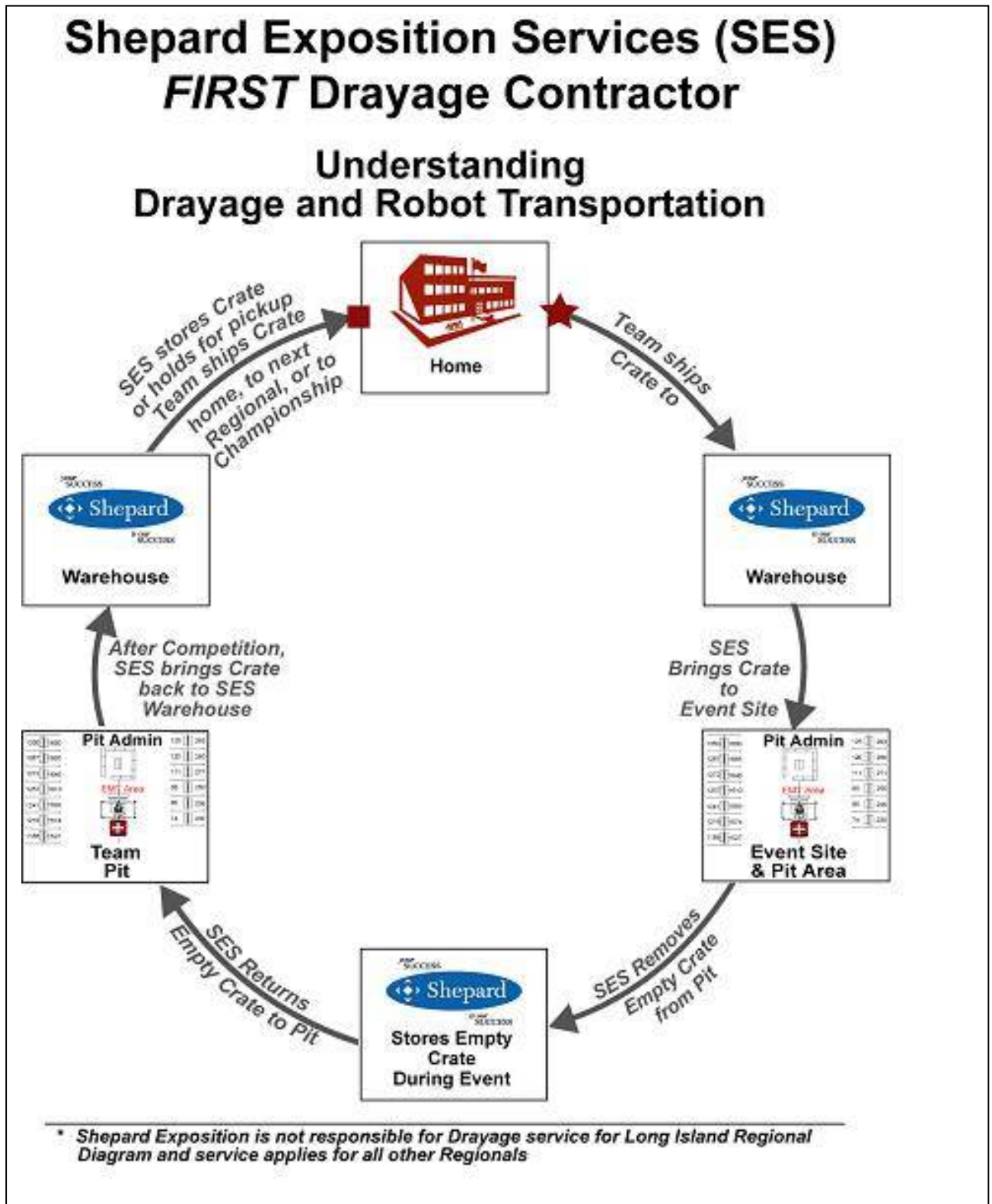

4.8. SHIPPING YOUR ROBOT

Event sites do not accept or store team robots, crates, or toolboxes. All teams must ship to a drayage warehouse facility, which stores the robots and then transports them to the event site and back to the warehouse.

If you ship two crates, both crates must adhere to specifications and deadlines. Teams are responsible for paying for ALL shipping charges at the time of shipment.

4.8.1. Teams have two shipping carrier options from event to event:

- 1) Refer to the FedEx® section below for specific information about free, donated shipping for ONE crate to ONE Regional and the Championship.
- 2) If you do not ship with FedEx, you must ship with the drayage carrier, Roadway, Inc. Refer to the “Roadway, Inc. Quotes” section and following sections for specifics.

4.8.2. Shipping to Your Initial Event

- Locate drayage information for your event(s) on the usfirst.org web site, *Event* section.
- Print, read, and save all relative sections of this manual and those relating to the FedEx shipping donation. Remember to bring the directions to your event.
- Also, read and follow directions in the “Shipping / Drayage” section for your event(s) on the *FIRST* Web site, Events area.
- Make shipping arrangements well before the ship deadline. *You may choose any carrier or drive your crate to the drayage warehouse for your initial event only.* (For subsequent events, you must use either the “house” carrier or FedEx.)
- If you decide to drive your crate(s) to the warehouse, *read the stipulations below regarding the delivery vehicle.*
- Obtain the best shipping rate to the drayage warehouse for your first event if you are not using the complimentary FedEx® ship. **NOTE:** You will need the total weight and dimensions of your crate and its contents for an accurate estimate.
- **If you don’t have a loading dock:** Be sure to tell your chosen shipper if your crate pickup area does not have a loading dock so it can send a truck with a lift gate.
- Obtain a dated Bill of Lading from your carrier. Retain all shipping documents, pro numbers, and/or airbill copies for tracking purposes and to provide the required information for the mandatory shipment verification process.

4.8.3. Crate Shipment Deadline and Requirement

ALL team robots/crates must leave the team's hands or be delivered to the team’s initial event’s drayage warehouse by **midnight local time February 20, 2007**. This date applies whether you ship your crate(s) or drive it to the drayage facility.

NOTE: Teams are responsible to work within the business hours of the shipper or drayage facility.

Roadway hours are Monday – Friday, 8 a.m. to 4 p.m. This includes the drayage terminal facilities.

- A. If you ship your robot, obtain written proof from your shipper that shows the date that the shipper took possession of your crate. Read below for rules about the “Mandatory Shipment Verification Process.”
- B. If you drive your robot to the drayage terminal, ask for written proof that shows the date you delivered your crate(s). Read below for rules about the “Mandatory Shipment Verification Process.”

4.8.4. Delivery Stipulations for Drayage Terminal and Delivery Vehicle

If your team decides to deliver its crate(s) to your initial event's drayage warehouse, the vehicle must be tall enough for a commercial loading dock. *Drayage personnel will not unload personal vehicles.*

YOUR DELIVERY TRUCK MUST HAVE A FORTY-EIGHT INCH (48) BED HEIGHT.

NO EXCEPTIONS! - You will be turned away at the warehouse if the vehicle 48" bed height requirement is not met!

4.8.5. Mandatory - Initial Crate(s) Shipment Verification Process

FIRST requires every team to document the shipment of its crate(s) for the initial event only. All crates must ship from event to event thereafter. Teams will disqualify themselves from competition for failure to observe and verify adherence to the rules and deadlines. *Please follow the instructions below for your chosen shipment method.*

4.8.5.1. If You Use the Online FedEx Shipping Administration System

- 1) If you use the FedEx Shipping Administration System (formerly FedEx PassKey System), it is not necessary to input your tracking number into the TIMS because we will generate a report that will provide *FIRST* with tracking numbers and crate pickup dates.
- 2) Save a copy of the airbill for tracking purposes and your records.

4.8.5.2. If You Drive Your Robot to the Drayage Facility

Refer above to the "Drayage Site Delivery Vehicle Stipulation" section. ***Your vehicle must have a 48" bed height, no exceptions.***

- 1) Have the drayage warehouse personnel put the time and date of drop off on an official receipt.
- 2) Write your team number on the receipt.
- 3) Make a copy and retain for your records.
- 4) Send it to *FIRST* so it arrives in 4 days. Address the envelope as below, using all capital letters.

4.8.5.3. If You Use an Alternate Shipper

Ensure that your receipt clearly shows the date and time the crate(s) left your team's hands.

- 1) Write your team number on the bill of lading/receipt.
- 2) Make a copy and retain for your records.
- 3) Provide shipping verification to *FIRST*:
- 4) **Teams outside the U.S.** - You will receive e-mailed instruction for providing the shipping verification.
- 5) **U.S. teams not using the donated/free FedEx shipping for your initial event:**
Mail a copy of your receipt to *FIRST* right away so it arrives within 4 days, addressing the envelope as below, using all capital letters. The properly addressed verification must arrive within 4 days.

4.8.6. Verification Mailing Address – Use capitals please.

YOUR TEAM #

TEAM SUPPORT, *Name of your initial event and its date*

FIRST ROBOTICS

200 BEDFORD STREET

MANCHESTER, NH 03101

4.8.7. Robots Must Ship from Event to Event

Teams cannot take their robots home between events. Crates must ship directly from event to event. Teams must ship their crates either:

- A. Through Shepard Exposition Service (SES) and its designated carrier, Roadway, Inc.
OR
- B. Through the FedEx complimentary shipping. *Bring the pre-printed airbill with you to the event on Saturday.* There will be no computer access at events.

Remember to print/ bring shipping address labels to each event in which you compete. Crates will return to the drayage terminal and ship from the drayage warehouse on Monday.

4.8.7.1. Back-to-Back Events (Consecutive Weekends)

Before choosing events on consecutive weekends, be sure to carefully consider the shipping and event deadline and expedited shipping cost aspects. *FIRST* discourages teams from competing in events on consecutive weekends if they are more than 1,000 miles apart. You must make all arrangements early to have your robot ship and arrive to the next event on time.

4.8.7.2. Expensive Shipments

The shipping costs for these back-to-back events are extremely costly. Compare shipping a small package to a location at a "ground" rate, and then compare the cost of sending it overnight. Use this same scenario to compare freight shipping rates for a 3 or 4-day freight shipment to an overnight or airfreight shipment. The difference can be staggering!

4.8.7.3. Mandatory Shipment with Roadway, Inc.

Contact your event's Drayage Company(s) well before both competitions to see if it can/will extend the crate arrival deadline for your team. You *must* use the Shepard Exposition Services' designated shipper, Roadway, Inc. You cannot use FedEx in this case, because FedEx generally does not pick up at events on Saturdays and your robot will not make the next competition on time. You must make all arrangements early to have your robot ship and arrive on time.

4.8.8. Delivery Deadlines

Each event has an "at drayage" deadline. Refer above to "Definitions." Make sure your shipper is aware of the deadline so you will meet it. Find the crate arrival deadline for each event by referring to the web site *Events* section.

4.9. FEDEX® EXPRESS FREIGHT SYSTEM COMPLIMENTARY SHIPPING

FedEx has again graciously agreed to partner with *FIRST* and donate specific robot crate shipping via the FedEx Express Freight System. Remember, this is a generous donation, and **you cannot substitute your shipment "home" for a shipment to another Regional.**

4.9.1. The FedEx Express Freight Donation

FedEx Express Freight will ship your crate to the Regional of your choice. FedEx will then ship it back "home" as the second benefit. **You cannot substitute your shipment home for a second Regional shipment.**

If your team is registered to compete at the Championship, FedEx Express Freight will also ship your crate to the Championship and back home. **NO SUBSTITUTIONS.**

Please familiarize yourself with the benefit shipping options below for competition in Regionals only or for Regional(s) and the Championship too. **NO SUBSTITUTIONS.**

Please see the table below.

Competing in: Regional Event(s) Only
<i>ONE</i> crate to any <i>ONE</i> Regional <i>ONE</i> crate home

Competing in: Regional Event(s) & The Championship
<i>ONE</i> crate to any <i>ONE</i> Regional <i>ONE</i> crate to the Championship <i>ONE</i> crate home

NOTES:

- 1) You cannot substitute your complimentary shipment “home” for a shipment to another Regional.
- 2) If you need your robot home soon after the Championship, you may want to use the Shepard Exposition Services (SES) shipper. Because of the crate volume of the donated shipments, it could take a month or so until you receive your crate.

4.9.2. Teams in the 48 Contiguous U.S. States

- 1) The teams in the U.S. contiguous states will use the on-line FedEx Express Freight Shipping Administration System to generate their complimentary airbills. Be grateful and generate them correctly and on time.
- 2) As a part of the Kit of Parts, teams will receive a Welcome Letter, which will lead them to the *2007 Robot Shipping* page of the *FIRST* Web site.
- 3) There, the Shipping Contact will receive instructions on how to proceed with printing the airbill from FedEx.com.
- 4) You can access this *2007 Robot Shipping* page and instructions at <http://www.usfirst.org/community/frc/content.aspx?id=3570> and link to a document called, *Ready to Ship –How to Ship from My Location*. This will provide your Shipping Contact with step-by-step instructions on how to proceed.

You must generate the airbills on line through this FedEx Shipping Administration System to receive the free shipment.

- If you use anything but FedEx Shipping Administration System airbills, you will be billed and you must pay for the shipment.
- If you use FedEx Shipping Administration System to ship to more than one Regional, you will be billed for it, and you must pay for the second shipment.

NEW NOTES:

- 1) **Follow the *FIRST* directions.** Please realize that FedEx does not change their system to meet our needs, so the general user directions for the FedEx Shipping Administration System may be different from ours. Follow the directions we supply.
- 2) **If you are shipping from a place without a loading dock,** when you call for pickup, make sure to tell FedEx that you need their pickup vehicle to have a lift gate.
- 3) Print out your FedEx Shipping Administration System airbill between Tuesday and Friday of the week you need to ship. Do not wait until Saturday in case you encounter problems. If you do not have a computer handy, go to a FedEx Kinko’s site to print out the airbill.
- 4) There will NOT be Internet access, computer, or a printer available at the competitions.
- 5) Remember to bring your instructions and password to the events if you need to print an airbill from your hotel computer or from a FedEx Kinko’s location.

If you are registered for the Championship, your return airbill will be in the registration envelope at that event.

4.9.3. Process – Teams in HI, AK, PR

FIRST will send a FedEx envelope with two (2) pre-printed airbills to your team's Shipping Contact. This will most likely be in early February.

If you are registered for the Championship, your return airbill will be in the registration envelope at that event.

4.9.4. Process – International Teams Competing in the U.S.

FIRST will send a FedEx envelope to your team's Shipping Contact, most likely in early February. It will contain the appropriate shipping airbill(s). Make sure you have all Customs papers in order for the shipment to and from the U.S.

If you are registered for the Championship, the airbill to ship your robot home will be in the registration envelope at the Championship event.

4.9.5. Weigh the Donation Value

Which event will give your team the most value for this donation?

- **You have back-to-back events:** FedEx does not pick up on Saturday, so you cannot use the donation for events on consecutive weekends. There is not enough time to make it from one event to the next drayage terminal/warehouse.
- **You are registered for more than one Regional:** See if your sponsor will ship your crate to the initial event since you must use either FedEx or the designated carrier to ship from event to event. Use the FedEx donated shipment for another.
- **Your initial event is close to home:** If you have the proper vehicle/bed height (48"), you could drive your crate to the event drayage facility and save the donation for a different Regional.

Complimentary shipments *do not* get high priority, so make sure there is enough time for this method of shipping, *especially after the Championship*.

4.9.6. Additional FedEx Important Notes

- FIRST cannot and will not replace lost airbills.
- **There will not be Internet access/computer/printer at the competitions to print airbills.**
- **You cannot use airbills with hand-written account numbers for these donated shipments.**
- You cannot use the FedEx Express Freight donation when shipping to back-to-back events.
- **FedEx will pay for one Regional ship only.** You cannot substitute a second Regional shipment for the Championship shipping benefit or for the ship home.
- **NEW:** When your robot ships back to the SES/Roadway drayage terminal for a FedEx shipment bear the following in mind to ensure your shipment leaves on time:

IMPORTANT: FedEx has/operates more than one Freight company.

FedEx **Express Freight** provides the shipping donation benefit to our teams.

If you use another FedEx service such as FedEx Freight, your team pays for the shipment.

- If you are using the donated FedEx shipments, FedEx Express Freight Services, the drayage facility will call FedEx for pickup. Put the proper paperwork/airbill on your crate.
- If you are using another FedEx Freight service, **you** must call FedEx for pickup, so FedEx sends the right truck for your shipment. Put the proper paperwork/airbill on your crate.
- **NEW: No loading dock at "home" delivery site:** On the "return home" airbill, note that the delivery truck must have a lift gate. Also note this on the SES/Roadway bill of lading.

- Refer below for instructions for International shipments and shipments from Hawaii, Alaska, Puerto Rico.

4.9.7. FedEx Weight Limit

Crates *cannot* exceed 600 pounds.

REMEMBER: *FIRST* pays drayage costs for *one* crate up to 400 pounds *only*. Teams pay the drayage cost in excess of 400 pounds, rounded *up* to the next hundredweight.

4.9.8. Shipment Insurance

FedEx does *not* insure complimentary shipments. If you want to insure your crate and its contents, obtain insurance through a third party.

4.9.9. **NEW:** International / Unusual Shipments

Read Building Restrictions/Laws Regarding Wood Materials before building your crate. This deals with regulations regarding required treated wood materials. Teams in the locations listed in the table below may receive e-mails regarding their shipments as the season approaches.

NOTE: Remember, if you attend the Championship, you will receive the “return home” airbill in your Championship registration envelope.

You will receive an “Expanded Service International Air Waybill” from *FIRST* if you are an international team. It is your responsibility to select a broker and document that information in section 6b of the “Expanded Service International Air Waybill.” If you fail to select a broker, your shipment may be delayed/detained in Customs. **Track your crate.**

No FedEx benefit will apply to back-to-back events.

Benefits for international shipments will vary.

a. International Priority

Teams shipping to events occurring in the first week may receive FedEx Express International Priority airbills via FedEx package from *FIRST*.

b. International Economy

If time between ship and event allows, the benefit will be FedEx Express International Economy Freight. Teams competing in events later than the first week will receive FedEx Express International Economy Freight airbills.

c. Shipments “home”

The FedEx Express International Economy benefit will apply to the international team shipments home. Consider the 5-7 business-day transit when planning post season events/celebrations.

See table below for specific benefits/instructions.

<p>.Alaska, Hawaii, and Puerto Rico</p>	<p>FedEx Express Freight 3-day freight is not available in these areas. These shipments require 2nd Day Air. Teams will receive airbills with the "Second Day Air" box already checked.</p> <p>Use the provided airbills for shipments within the continental U.S.</p> <p>Track your shipments.</p>
<p>Brazil The Netherlands The United Kingdom</p>	<p>This FedEx donation will be International Economy Freight with a 5-7 business-day transit time to the U.S. <i>FIRST</i> will send the appropriate airbill(s) to your Shipping Contact in a FedEx packet in February.</p> <p>Teams registered for the Championship event will receive the airbill for shipment home in their registration packet at the Championship.</p>
<p>Canada</p>	<p>Because FedEx Freight service is not offered within Canada, FedEx is not able to provide the donation of shipments within Canada. FedEx</p>

	<p>does donate shipments to Canadian teams that cross the Canadian/U.S. border or those shipments within the U.S.</p> <p>Teams must use a FedEx International Airbill to ship across the Canadian border to the U.S. <i>FIRST</i> will send the appropriate airbill(s) to your Shipping Contact in a FedEx packet in February.</p> <p>Return robot shipments will use the International Priority Freight benefit.</p> <p>Remember to fill out required Customs papers.</p> <p>If you will be shipping to the Championship from a U.S. event, we will provide a domestic airbill. If shipping to the Championship from a Canadian event, we will provide an addressed International airbill.</p> <p>Track your shipments.</p>
Israel	<p>Teams registered for the Championship event will receive a FedEx International Priority Freight donated shipment to that event.</p> <p>The robot shipment home from the Championship will be International Economy Freight. <i>FIRST</i> will send the appropriate airbill (s) to your Shipping Contact in a FedEx packet in February.</p> <p>Teams registered for the Championship event will receive the airbill for shipment home in their registration packet at the Championship.</p>
Mexico	<p>Teams must use a FedEx International Airbill to ship across the Mexican border to the U.S. <i>FIRST</i> will send a FedEx Express International Expanded Air Waybill marked with the International Economy benefit. This will arrive in a FedEx packet in February.</p> <p>Teams registered for the Championship event will receive the airbill for shipment home in their registration packet at the Championship.</p>

4.9.10. NEW: The FedEx Shipping Administration System (formerly Passkey)

This is an on-line ship manager process, formerly known as Passkey, which allows registered teams in the contiguous 48 U.S. states to print their own airbills. Refer to above sections for stipulations of the benefit.

4.9.11. Printing the airbill

Find the instructions for this process at the *2007 Robot Shipping* page at <http://www.usfirst.org/community/frc/content.aspx?id=3570>

The Shipping Contact should become familiar with the instructions.

- He/she will be able to enter the system, choose the event, fill in a limited amount of information and print out an airbill with a tracking number.

4.9.12. Using the airbill

- Place the airbill in the plastic sleeve, and attach it to the side of your crate. Refer above to "Crate Labeling" section.
- Keep a copy of the airbill for tracking purposes. Put it in a safe place, and once your crate ships, track it.
- If you choose to use the one donated Regional shipment to ship from an event, bring the airbill and sleeve to the event and put it on the team's crate on the last day of that event.
- *There will be NO airbill replacements.* Airbills with a handwritten account number will not be accepted for these free shipments.

Remote areas: You will probably have to make arrangements in advance with your local FedEx Express Freight office. To find your local FedEx contact, do the following:

- Go to <http://www.fedex.com/us/ExpressFreight/>

- Scroll to “Use Service Area Locator” and click.
- Remote area teams should call a few days in advance to see if there are additional instructions for pickup in your area.

Arrange for Crate Pickup: Call 24 hours in advance to schedule pickup. If you are in a remote area, you should *make arrangements early*.

United States	Canada
Call FedEx Express Freight Services 800-332-0807	Use the Canadian Call Center: 866 744 7493
International teams	
Go to fedex.com , choose your country, and locate the appropriate phone number	

- You will need the account number from the airbill.
- You will need to provide your crate’s dimensions and total weight.
- Ask for Express Freight Services. Emphasize that it is a heavy weight shipment and provide the type of shipment for the area that you will be shipping to/from. See table below.

Area	Shipment Type
Contiguous 48 states-	F3 Express Freight 3-day
Alaska, Hawaii, Puerto Rico	F2 Express Freight 2-day
Canada	IPF International Priority Freight
Israel-	IP2 - International Priority Freight to the U.S. IEF - International Economy Freight back to Israel
Brazil- United Kingdom- The Netherlands-	IEF International Economy Freight inbound and outbound
Mexico	IEF International Economy Freight inbound and outbound

- **If your pickup/return site does not have a loading dock**, be sure to tell the representative that you need a truck with a lift gate. (This may apply to your initial shipment to/from your home base)
- **Track your crate.** Allow 3-5 days for shipment movements.

4.10. ROADWAY, INC. QUOTES

If you do not ship with FedEx, you *must* ship from event to event with the Shepard Exposition Services Carrier, Roadway, Inc.

Roadway hours are Monday – Friday, 8 a.m. to 4 p.m. This includes the drayage terminal facilities. To obtain a freight quote for shipping crates to a SES/Roadway drayage terminal, please contact SES Customer Service at (704) 394-9140.

- 1) Identify yourself as a *FIRST* Robotics team
- 2) Provide your team number

- 3) Provide your event name, city, and state

To help with this process, Nina Nemeth from Shepard Exposition Services will be contacting all participating teams registered for more than one Regional event.

NEW: CHARGES NOTES:

- Do not use the Rating System on the Roadway Web site. These calculations are the retail price, and do not reflect the discount provided for FRC teams robot shipments.
- Your shipment may have additional charges, such as a re-weight charge.
- If your delivery area does not have a loading dock, you will need a truck equipped with a lift gate, and there is a charge for this.
- All shipments will also have a fuel surcharge at a commodity price.

4.11. TRACK YOUR CRATE

Track your crate to ensure on-time crate delivery to the event.

Please do *not* call Shepard Exposition Services (SES) to track your crate if you shipped FedEx.

FedEx Shipment Tracking	SES Roadway, Inc. Shipment Tracking
Use the FedEx Customer Service Center at http://www.fedex.com/ , or call (800) 463-3339. (800 Go FedEx) Have your twelve-digit tracking number available.	Call 800 531 3976 Follow the telephone prompts for tracking. Have your pro number available. If you need assistance, call SES or, go to www.roadway.com

4.12. DRAYAGE

Every team has to ship its competition crate(s) to the designated drayage terminal/warehouse for each event it attends. *You cannot, under any circumstances, drive or ship crates to competition sites.*

Roadway, Inc., c/o Shepard Exposition Services (SES) is the designated Drayage Company for all events except the SBPLI Long Island Regional. FESTO Corporation handles drayage for that event. All instructions apply for both drayage companies.

- 1) Label your crate properly. If it doesn't meet required specifications, the SES/Roadway or FESTO terminal may refuse it.
- 2) Well ahead of shipping time, find drayage information and overweight (overage) costs for all events in which your team will compete. Go to <http://www.usfirst.org/community/frc/content.aspx?id=430> and click on your event.
- 3) Refer to all related sections below.

4.12.1. The Drayage Companies: Functions and Services

FIRST contracts with a drayage company for each event to provide the following services to:

- 1) Provide **FIRST** with a system to monitor on-time crate arrival
- 2) Provide robot storage prior to the event
- 3) Ensure on-time crate delivery to team Pit stations at the competition sites
- 4) Provide storage for empty crates at the venue
- 5) Provide a staging location for outbound shipments
- 6) Protect staff and teams from crowded load-in and load-out situations
- 7) Comply with venue contracts, which prohibit the acceptance of shipments on site.

4.12.2. Drayage Company Regulations

Teams cannot take their robot/crates home from any event. They must ship through the SES designated carrier, Roadway, Inc. or use their donated FedEx Express Freight shipment when shipping between events. Drayage personnel are not allowed to, and will **not**, load your crate onto your vehicle.

- **All shipments must be prepaid:** The Drayage Warehouse will not accept Cash on Delivery (COD) shipments. Teams must take care of this with the carrier prior to sending a shipment to a drayage site.
- **Use only designated shippers:** Teams must use FedEx or the designated SES shipper (Roadway, Inc.) for crates shipping from event to event.
 - 1) **FedEx:** Consider using your final FedEx Express Freight airbill to ship home from your last event if you do not need your robot right away. Remember, these are donated shipments and the final return can take a month or more, especially after the Championship.
 - 2) **Shepard Exposition Services Carrier:** (Roadway, Inc.) When not using FedEx, teams must make on-site arrangements through the SES desk and the Roadway, Inc. representative. Teams shipping from the Long Island event must also use Roadway, Inc. Freight or FedEx.
- **Freight Bills, Weight Receipts:** Shipments received without freight bills or specified unit counts on receipts will be delivered to team Pit Stations without guarantee of piece count or condition. When receiving freight, the drayage terminal requires that drivers submit a *certified weight receipt*. The company reserves the right of refusal to unload shipments without it.
- **Bills of Lading:** All shipments must have a Bill of Lading or delivery receipt showing:
 - 1) Number of items, weight, and description of merchandise
 - 2) All Items labeled per Regional/Championship event specifications
- **Damage:** The drayage terminals will not be responsible for damage to uncrated materials, improperly packed materials, any concealed damages, loss, or theft of materials after crates have been picked up for loading out of the competition site.
- **Weigh In:** The drayage terminals will weigh team crates as they arrive at each facility. These weights will be certified, and any crates exceeding four hundred pounds will be subject to drayage overage fees. *If a team wants to dispute the weight of its crate, a scale will be on site at each event for reweigh within the specified time.*

4.12.3. Freight Overage

All teams must pay for drayage overage in advance, prior to the competition. If a team refuses to pay overage charges, the drayage companies may refuse return of the team's crate until payment is reconciled at the service desk. Upon payment receipt, it will return the crate(s).

NEW: For SES terminals, you must fill in the *Payment Authorization Form* if you know your crate will be overweight. Download this form, which is part of your "Shipping / Drayage" information for your event(s). <http://www.usfirst.org/community/frc/regionalevents>.

Fax it to 704 398 0914.

Accepted Payment Forms for SES: The following are accepted credit cards for overage fees: (MasterCard, Visa, or American Express) If paying by school check, the check must arrive at SES *before* the team participates in the event. All overage payments are due at Shepard Exposition Services 15 days post event.

4.12.4. Immediate On-site Crate Weight Complaint Resolution, 7:45a.m.-8:30a.m.

NEW: Because of safety requirements, crates are removed from the Pit as early as possible. The time set aside for weight discrepancy resolution is from 8 a.m. to 8:30 a.m.

When team members arrive at the Pit Station to uncrate the robot:

- 1) Read the label Shepard Exposition Services (SES) placed on your crate.
- 2) If your crate shows a weight over 400 pounds, and if you have any question as to the accuracy of the weight or information on the label, *immediately* find an SES representative to ask for a re-weigh. See the Pit Administration Supervisor if you cannot find a representative.
- 3) *Do not open the crate until you have received a re-weigh.* **NOTE:** If you open the crate, you relinquish any appeal rights.
- 4) Do not leave your Pit station until the re-weigh.

4.12.5. Weight and Rates Structure

Rounding Up: Drayage Companies weigh by the hundredweight and round the weight up to the next hundred. Make a real effort to keep weight down to well below the hundred marks to allow for scale calibration differences.

Example: If your crate weighs 401 pounds, your charge will be based on five hundred pounds, and you will have to pay for a hundred pound overage for that crate. Refer to the Events section of the web site, click on your event and “Shipping / Drayage” for material handling rates.

<http://www.usfirst.org/community/frc/>

4.12.5.1. Drayage Costs - FIRST

FIRST will pay for the Material Handling (drayage) cost of *ONE* crate, *within criteria limits*, for each team, for each *FIRST* competition in which it competes this season.

Refer to *Crate Information, Crate Size, and Weight Specifications* section for specifics.

4.12.5.2. Drayage Costs - Teams

The following will cost teams money:

- 1) Crate exceeding measurement or weight specifications
- 2) Any additional crate. Teams pay *entire* drayage cost of additional crates

NOTE: Each team must pay for any additional material-handling charges by the end of each competition.

4.12.6. Outbound Shipments from the Drayage Terminal

SES will bring crates back to its warehouse or a Roadway, Inc. terminal on Saturday after the competition. Crates will be available for outbound shipping from the warehouse on Monday, with the exception of shipping from the Championship.

NOTE: The crates from the Championship, shipping via FedEx Express Freight donated shipping, will ship at FedEx convenience.

- 1) Teams must ship their robots. Teams cannot take robots or crates with them from an event.
- 2) Be sure to:
 - Ensure your crate is still fit for travel.
 - Pre-pay for all applicable outbound shipping charges.
 - Fill out an Outbound Bill of Lading (BOL) – (Shepard Logistics Services Material Handling Authorization and Transportation Agreement) for SES events.
 - At SES handled events, a representative will pass out one of these forms to each team on the last day of the event. See example next page.
 - **NEW:** If you are shipping “home,” and the delivery site has **No loading dock**, note your request a delivery truck with a lift gate in the “Exceptions” area on

the SES form. For the Long Island Regional, as the drayage representative where to make that note.

- Remove the old shipping labels.
 - Attach the address and battery labels for the next event to all sides of the crate...at a readable level.
 - Make arrangements for the outbound shipment.
- 3) **Using Fed Ex?** Attach your airbill to your crate. Retain a copy for tracking purposes, write your tracking number above the “Exceptions” area on your Outbound BOL, and turn it in at the SES shipping desk. You will receive a copy.
- 4) **Using Roadway, Inc.?** Turn in your Outbound BOL to the SES shipping desk representative. You will receive a copy with an assigned Pro number. Retain this copy for crate tracking.

ROADWAY TRACKING

You should see movement on your shipment beginning the Wednesday after the event.

<http://www.roadway.com> and insert your Pro # and press “Go”

For back-to-back shipments with Roadway, begin tracking on Monday. For problems, contact Customer Service at SES, (704) 394-9140, and provide your *FIRST* team number.

FEDEX TRACKING

You should see movement on your shipment by Wednesday after the event.

<http://www.Fedex.com> and choose Freight Services, choose “Express Freight” to track.

Insert your tracking number.

Contact FedEx if you don't see movement by Wednesday. (800) 463-3339

4.12.7. Example of SES Outbound Bill of Lading

You will receive an outbound bill of lading from the SES/Roadway Service desk at each event. Fill out the indicated areas for your outbound shipment, whether you ship with FedEx or Roadway.

PRESS HARD YOU ARE MAKING 5 COPIES!

IF SHIPPING WITH SHEPARD LOGISTICS TO:

SHEPARD LOGISTICS SERVICES
MATERIAL HANDLING AUTHORIZATION AND TRANSPORTATION AGREEMENT

Shepard

RATE QUOTE [] BASED ON [] POUNDS

EXHIBITOR: PLEASE RETURN COMPLETED AGREEMENT TO THE SHEPARD CUSTOMER SERVICE CENTER

RCVD. **LEAVE** BY **BLANK**

Date Time

PLACE PRO # HERE

FROM: **TEAM # FEDEX OR ROADWAY** TO: **THIS SPACE SHOULD HAVE YOUR NEXT EVENT**

FROM: **OFFICIAL TEAM NAME** TO: **NAME OF THIS REGIONAL**

FROM: **DRAWAGE ADDRESS OF THIS REG.** TO: **DRAWAGE ADDRESS - OR**

FROM: **CITY** TO: **HOME SHIPPING ADDRESS**

FROM: **STATE ZIP**

Type of service: Ground Next Day Air 2nd Day Air Other

★ Shipments moving via air; Liability will be limited to .50¢ per pound per article. Additional insurance to cover excess declared value will be purchased at \$1.00 per \$100.00 of value at Exhibitor's expense. ***IF SHIPPING FEDEX WRITE TRACKING # HERE**

DECLARED VALUE OF ENTIRE SHIPMENT \$

No. Pcs # OF COPIES	Description of articles	Weight	Exemptions
	Corrugated Exhibit Material (wooden) KD	IF YOU KNOW IT	*IF LIFTGATE IS REQUIRED FOR SHIPMENT TO HOME BASE (NO LOADING DOCK) NOTE HERE
	Cartons Exhibit Material KD		
	Cases / Trunks / Boxes		
	Slides / Plates		
	Carpet		
	← TOTAL PIECES		← TOTAL WEIGHT SUBJECT TO VERIFICATION AND CORRECTION

In the event your designated carrier fails to show by _____, please select an option:

Reroute via show carrier Shepard Logistics at exhibitor's expense. (credit card must be on file for this option)

Deliver to local warehouse at exhibitor's expense.

Reroute to optional carrier assigned by Shepard Logistics. (This option will be used if credit card is not on file)

Signature _____

Reroute via _____ by _____

Date _____ Time _____

AUTHORIZATION FOR SERVICES
IMPORTANT! PLEASE READ CAREFULLY:
 You are entering a contract which defines the respective responsibilities and liabilities of the parties. Terms and conditions of the contract are on the reverse side of this form. Shipper's signature indicates authorization for services, correctness of above information, and agreement to terms of contract.

Shipper's name: **PRINT YOUR NAME**

Signature: **YOUR Signature** Date: **DATE**

Carrier's name: _____

Carrier's address: _____

City: _____ State: _____ Zip: _____

NOTE - ADDITIONAL FEE IS CHARGED AND APPLICABLE TO FIRE, BURGLARIES AND DELIVERY EXCEPTIONS

Above listed articles received in good condition. Except as noted.

Center name (Print): _____

Driver (Print): _____

Center address # _____

Signature: _____

LEAVE BLANK

4.13. WE JUST QUALIFIED FOR THE CHAMPIONSHIP

4.13.1. What do we do? Is there a Decision Deadline?

If you are unsure whether your team can go to the Championship, you have *until the Tuesday following your qualifying event* to inform *FIRST* and SES whether you will attend and register for that event. If this is your last event, you have until Tuesday to let the drayage company know whether you will be shipping home or to the Championship. Follow instructions below.

4.13.2. Undecided? Temporary Crate Shipment “Hold, Then Ship”

If you are not sure your team can attend the Championship (CMP), read below for the “hold” process.

- Make sure you talk with the SES / Roadway, Inc. representative at the event (or the FESTO Corporation representative if at the Long Island event). Explain your situation and make temporary arrangements per the directions below.
- Put an 8 ½” by 11” sign on your crate, near your shipping airbill. It should say:
- Consider shipping your tools also if you have room and if you can safely pack them in your crate.

**Team will call.
Hold until Tuesday.**

- Teams that qualify for the Championship at an event can obtain a FedEx Express Freight airbill from the Event Manager. *FIRST* supplies these pre-printed, official documents prior to the events.
- Label your crate:
- Fill in your donated FedEx Express Freight airbill with the team’s “home” shipping address OR the address for the Championship drayage warehouse. You can look in the FRC Manual at the Pit Administration Station for the Championship drayage terminal address.
- Place the airbill on your crate if shipping FedEx. Keep your copy.

Create and place one address label on each facing side of the crate if you are shipping to the CMP.

- Make sure you still have the battery labels on the four sides of your crate and the inner battery box.
- Fill in a Bill of Lading and write your tracking number on it if shipping FedEx.
- **You must inform the drayage terminal of your shipping intentions by Tuesday.**
- Follow up on your shipping arrangements.
- Always Track your shipment.

Because of possible liability, the drayage company will not fill out a FedEx airbill for your team.

4.13.3. We Changed our Minds

- If you find that you are not shipping to the address on your airbill, you must ship through the SES carrier. Call to make the arrangements, provide the new shipping address, and prepay the shipment.
- Always track your shipments to ensure a timely delivery.

THE AWARDS**TABLE OF CONTENTS**

5 THE AWARDS	3
5.1 FIRST ROBOTICS COMPETITION AWARDS.....	3
5.2 THE AUTODESK INVENTOR AWARD (CHAMPIONSHIP ONLY)	3
5.2.1 Purpose of Award:.....	3
5.2.2 Award Overview	3
5.3 THE AUTODESK VISUALIZATION AWARD	3
5.3.1 Purpose of Award.....	3
5.3.2 Award Overview	3
5.4 CHAIRMAN'S AWARD	4
5.4.1 Overview	4
5.4.2 First-Year (Rookie) and NASA Grant Teams:.....	4
5.4.3 Submission Information.....	5
5.4.4 Judging Process.....	7
5.4.5 The Allaire Medal - Leadership Exemplified	7
5.5 CHAMPION (CHAMPIONSHIP ONLY)	8
5.6 CHAMPIONSHIP FINALIST (CHAMPIONSHIP ONLY).....	8
5.7 DAIMLERCHRYSLER TEAM SPIRIT AWARD	8
5.8 DELPHI "DRIVING TOMORROW'S TECHNOLOGY™" AWARD	8
5.9 DIVISION FINALIST (CHAMPIONSHIP ONLY).....	8
5.10 DIVISION CHAMPION (CHAMPIONSHIP ONLY).....	8
5.11 ENGINEERING INSPIRATION AWARD	8
5.12 THE FOUNDER'S AWARD (CHAMPIONSHIP ONLY)	8
5.13 GENERAL MOTORS INDUSTRIAL DESIGN AWARD	9
5.14 HALL OF FAME (CHAMPIONSHIP ONLY).....	9
5.14.1 DVD Submission	9
5.14.2 Display Specifications	9
5.14.3 Hall of Fame Teams.....	9
5.15 HIGHEST ROOKIE SEED AWARD	10
5.16 IMAGERY AWARD	10
5.17 JOHNSON & JOHNSON - SPORTSMANSHIP AWARD	10
5.18 JUDGES' AWARD	10
5.19 KLEINER PERKINS CAUFIELD & BYERS ENTREPRENEURSHIP AWARD	10
5.20 MOTOROLA QUALITY AWARD.....	11
5.21 REGIONAL FINALIST (REGIONAL ONLY)	11
5.22 REGIONAL WINNER (REGIONAL ONLY)	11
5.23 ROCKWELL AUTOMATION INNOVATION IN CONTROL AWARD.....	11
5.24 ROOKIE ALL-STAR AWARD	11
5.25 ROOKIE INSPIRATION AWARD.....	11
5.26 UNDERWRITERS LABORATORIES INDUSTRIAL SAFETY AWARD.....	11

5.27 XEROX CREATIVITY AWARD	11
5.28 WEBSITE AWARD	11
5.28.1 Submission and Deadline Information	12
5.28.2 Scoring Criteria.....	12
5.28.3 Evaluating Process	13
5.28.4 Award Presentation	13
5.29 2007 WEBSITE AWARD SCORING SHEET	14
5.30 WOODIE FLOWERS AWARD	15
5.30.1 Award is Students' Choice	15
5.30.2 Spirit of the Award	15
5.30.3 Judging Criteria	16
5.30.4 Entry Requirements.....	16
5.30.5 Submission Deadline.....	16
5.30.6 Entry Process	16
5.30.7 Prior Regional Woodie Flowers Award Winners	17
5.31 FIRSTAWARDS.ORG SITE.....	18
5.31.1 Formatting	18
5.31.2 Accounts	18
5.31.3 Verification of Submission.....	18

5 THE AWARDS

5.1 FIRST ROBOTICS COMPETITION AWARDS

This chapter contains descriptions of the *FIRST* Robotics Competition Awards as well as any required submission criteria. Note an asterisk designates a new or “changed” award in the listing. The “Rockwell Automation Innovation in Control” Award was previously known as the RadioShack Innovation in Control Award. Unless otherwise noted all awards are given at both the Regional events and the *FIRST* Championship.

FIRST will hold an Awards Celebration at each Regional and at the Championship presenting these awards.

5.2 THE AUTODESK INVENTOR AWARD (CHAMPIONSHIP ONLY)

5.2.1 Purpose of Award:

This award honors excellence in student mechanical design, coordination, and presentation.

5.2.2 Award Overview

Autodesk wants to honor those young inventors and engineers that make the *FIRST* Robotics Competition possible! Once again we are excited to offer the Autodesk Inventor Award. With Autodesk Inventor we have provided the tool that allows you to design without limits. Now we want to see what you do with this tool. We know that before your team can start building your robot you need to design it. We want to see the exciting journey of how your designs evolved into a real-life robot! Autodesk Inventor allows you to quickly and easily design and modify your robot using the same iterative techniques employed by professional engineers.

From concept through completion, the Autodesk Inventor Award was created to honor those who bring their ideas to reality.

Additional information about this award, along with the specific award criteria, judging process and deadlines will be posted on the Autodesk website: www.autodesk.com/firstbase

5.3 THE AUTODESK VISUALIZATION AWARD

5.3.1 Purpose of Award

This award honors excellence in student animation.

5.3.2 Award Overview

All *FIRST* teams are invited to create a submission for the Autodesk Visualization Award (AVA) using Autodesk **3ds Max**® software. Additional information about this award, along with the specific award criteria, judging process and deadlines will be posted on the Autodesk website: www.autodesk.com/firstbase for the Championship.

Regional judging will be peer based, one student animator per competing team will review and score the competing animations on site. More information is available on the *FIRST* website.

Note: In 2007, *FIRST* will showcase Autodesk Visualization animations at each regional event. We are committed to honoring the student teams who undertake this challenge by showing the animations created by each team participating at the Regional event. Autodesk will continue to support this effort by providing a compilation DVD for each Regional event.

5.4 CHAIRMAN'S AWARD

The *FIRST* Robotics Competition is about much more than the mechanics of building a robot or winning a competitive event. It is about the partnership among people who are part of the *FIRST* community and the impact on those who participate in *FIRST* programs with a united goal of achieving *FIRST*'s mission. *FIRST*'s mission is to change the way young people regard science and technology and to inspiring an appreciation for the real-life rewards and career opportunities in these fields.

The concept of the Chairman's Award includes Regional Chairman's Awards, which enable *FIRST* to recognize more teams for their exemplary efforts in spreading the *FIRST* message, as well as their talents in organizing materials for their presentations.

The winning entries of the Regional Chairman's Awards will travel to the Championship for the continuing process of consideration for the most prestigious 2007 Chairman's Award.

5.4.1 Overview

The Chairman's Award was created to keep the central focus of the *FIRST* Robotics Competition as our ultimate goal for transforming the culture in ways that will inspire greater levels of respect and honor for science and technology, as well as encourage more of today's youth to become scientists, engineers, and technologists

The Chairman's Award represents the spirit of *FIRST*. It honors the team that, in the judges' estimation, best represents a model for other teams to emulate, and which embodies the goals and purpose of *FIRST*. It remains *FIRST*'s most prestigious award.

FIRST will present a Regional Chairman's Award at each regional competition. There are thirty-seven (37) regional competitions scheduled for the 2007 season, therefore, there will be thirty-seven Regional Chairman's Award winners. Only the winners of the Regional Chairman's Award will be eligible to compete for the Chairman's Award presented at the *FIRST* Championship.

Hall of Fame members, a/k/a teams that have already won the Chairman's Award are ineligible to compete for the Regional Chairman's Award. However, as *FIRST* believes that the process of submitting for the Chairman's Award is a very valuable exercise in itself, *FIRST* encourages Hall of Fame members to complete a submission which will be used by Hall of Fame judges to verify that each Hall of Fame team is maintaining its Hall of Fame status. Accordingly, all submissions by Hall of Fame teams will be electronically routed to a folder judging as part of the Hall of Fame.

5.4.2 First-Year (Rookie) and NASA Grant Teams:

Because the Chairman's Award recognizes sustained excellence and impact, not just a one-year team effort, it is not possible for a first-year (rookie) team to receive this honor. However, *FIRST* invites and encourage rookies to develop a Chairman's Award submission which may be evaluated by the judges determining the winner of the **Rookie All-Star Award**. This submission will document where your team started its *FIRST* journey and will also provide background for documenting the results of your team's efforts – it will be a great way to start your team's efforts to win the Chairman's Award.

Rookie Teams: If you prepare a Regional Chairman's Award, print a copy to give the Judges when they visit you at your Pit Station, judges will not be viewing them online.

Teams receiving **NASA Grants** must provide a copy of this submission as part of the grant.

All teams are encouraged to print a copy of their final submission for their records and to confirm for themselves that the submission was accepted.

5.4.3 Submission Information

The criteria for the 2007 Chairman's Award are essentially identical to those in 2006, with special emphasis on recent accomplishments in both the 2006/2007-year and the preceding two years. The judges focus on teams' activities over a sustained period, as distinguished from just the six-week design-and-build time frame.

The *FIRST* Robotics Competition is not about machines; it is about the experience of people working together toward a shared goal. Documenting and preserving your team's *FIRST* experience becomes an important component of the over-all *FIRST* experience.

As in the past, teams may only submit at one Regional competition for judging. Teams submitting for both the Chairman's Award and the Woodie Flowers Award should note that both awards are judged at the same event. Students working on the Woodie Flowers Award submission and those team members working on the Chairman's Award submission should coordinate to select the best event for the team.

5.4.3.1 Submission Content

The Chairman's Award is presented to the team judged to have created the best partnership effort among team participants and which best exemplified the true meaning of *FIRST* through measurable impact on its participants, school, and community at large. There is no single "best way" for a team to win the Chairman's Award. Many factors come into play. The primary factors the judges will evaluate are:

- 1) How strongly does the submission document the impact *FIRST* has on the learning experience of the students, school curriculum, engineers, and/or community during the 2006/2007 team year as well as in prior years?
- 2) Has the team explained/demonstrated why/how it should be a role model for other *FIRST* teams to emulate?
- 3) How well has the team communicated its excitement and impact within the entire school, community, and beyond (state/nation) through participation in *FIRST* during the 2006/2007 team year as well as in prior years?
- 4) Has the team documented an innovative way to spread the *FIRST* message?
- 5) How strong of a year-round team partnership effort is reflected during the 2006/2007-team year as well as in prior years? (You can define partnership in many ways, including: the partnership among the team's students/corporate sponsor/engineers; school/university sponsor/engineers; students/adults; community/team)
- 6) As a whole, does the content of the documentation exemplify the true meaning of *FIRST*?

Your Chairman's Award submission should include documentation for all the above factors.

5.4.3.2 Submission Format

Regional Chairman's Award submissions will be submitted on line. The submission, excluding the Executive Summary, will be limited to 10,000 characters, including spaces and punctuation, and may include up to four (4) photographs totaling no more than 1.0Mb of memory.

Submission Process

The URL for the Chairman's Award Submission is www.firstawards.org/ Follow the directions shown on the site to submit your team's entry. Teams may only submit at one regional event at which the team will compete. This site will be available beginning January 16, 2007 at noon EST.

Submitters can easily enter information, save it, and return to the site to edit the Chairman's Award submission until they are ready to submit it for final judging. All entries will be final on

Thursday, February 22, 2007 at 11:59 p.m. EST. No entries will be accepted or altered after this date.

Chairman's Award submitters will go to the website and enter the required information.

Team Number:

Regional Selection:

Executive Summary – Teams ***must complete the following fields*** in order to be considered for this award. The information included in the Executive Summary is not included in the total character/word count for the Chairman's Award Submission.

- Team Name
Corporate/University Sponsors
- Briefly describe the impact of the *FIRST* program on team participants with special emphasis on the 2006/2007 year and the preceding two years (500 characters allowed, including spaces and punctuation)
- Examples of role model characteristics for other teams to emulate (500 characters allowed, including spaces and punctuation)
- Describe the impact of the *FIRST* program on your team and community with special emphasis on the 2006/2007 year and the preceding two years (500 characters allowed, including spaces and punctuation)
- Team's innovative methods to spread the *FIRST* message (500 characters allowed, including spaces and punctuation)
- Describe the strength of your partnership with special emphasis on the 2006/2007 year and the preceding two years (500 characters allowed, including spaces and punctuation)
- Team's communication methods and results (500 characters allowed, including spaces and punctuation)
- Other matters of interest to the *FIRST* judges, if any (500 characters allowed, including spaces and punctuation)
- Upload pictures (maximum of 4 allowed, not to exceed 1.0Mb in total)
- Essay (10,000 characters allowed, including spaces and punctuation, or approximately 1500 words)
- Electronic signature of Team Captain/Student Representative certifying that the document is complete and accurate
- Electronic signature of adult team mentor certifying that the document is complete and accurate

Once the Chairman's Award submissions are completed, they are sorted and posted on a private, password-protected site where only the judges can read the entries. Each regional will have all the candidates who successfully completed the submission listed and the judges will review the submissions. Teams should always print and bring a hard copy of their submission to the event.

In preparing this document, bear in mind that students, engineers, teachers, community, school, sponsors, families, and other supporters, as well as the machine itself are all integral parts of your team experience. Your submission does need to clearly convey the factors outlined above.

- **Important Note:** Chairman's Award Judges look for and review the information entered in the *Yearbook Page* as part of the Chairman's Award submission. This information is entered as part of the Team Information Management System (TIMS) at www.my.usfirst.org/ Refer to *Section 1 Communications* for more details about the *Yearbook Page*.

5.4.3.3 Submission Deadline

Chairman's Award submissions are **due no later than Thursday, February 22, 2007. 11:59 p.m. EST.**

5.4.4 Judging Process

5.4.4.1 The Regional Award Process:

By 10 a.m. on Friday mornings of each Regional Competition a list of interview times (which will either be pre-assigned by the judges or available for self selection by the teams, at the option of the judges) for the submitting teams will be available at the Pit Administration station. Interviews will take place during the day on Friday. A panel of judges will review the Chairman's Award entries at each Regional and will conduct on-site Chairman's Award interviews with those teams who have entered a submission for that regional event. Judges will select one winner for the Regional Chairman's Award at each regional competition.

Interviews are limited to ten (10) minutes with not more than three (3) team members (student or adult mentors). The team selects these representatives. During the first five (5) minutes of the interview, the team members give a presentation to the judges, and the judges will use the second five (5) minutes for their questions and answers.

NOTE 1: If the presentation requires special equipment, the team is responsible for bringing it to the interview, and the time required to set up the equipment will count as part of the team's allotted 5 minutes.

NOTE 2: Teams are encouraged to bring copies of documentation, supporting their submission, to leave with the judges. This documentation may include, but is not limited to:

- Letters of reference
- Newspaper and magazine articles
- Program Books

As part of the Chairman's Award judging process, *FIRST* judges will also review the Executive Summary page *AND* the yearbook page for each of the submitting teams. Your team's submission will be a key factor in the selection process, along with the judges' own observations of the team at the competitions.

5.4.4.2 The Chairman's Award Championship Award Process

At The Championship, a panel of judges will review the winning thirty-seven (37) Regional Chairman's Award submissions and will select one ultimate Chairman's Award winner. This winning team has the additional honor of choosing one of its junior or senior student members to be the recipient of the Allaire Medal.

5.4.5 The Allaire Medal - Leadership Exemplified

The Chairman's Award is presented at the Championship to the *FIRST* team judged to have the best partnership effort. The Allaire Medal recognizes leadership exemplified and is awarded to an individual student on the winning Chairman's Award team.

Named in honor of Paul A. Allaire, a long-serving *FIRST* Chairman of the Board, the Allaire Medal is given to the student who has demonstrated outstanding leadership on his/her *FIRST* team, within his/her school and community, and whose personal character best embodies the spirit of *FIRST*.

The team receiving The Chairman's Award at the Championship will select the Allaire Medal recipient. The adult and student team members determine the winner. The recipient must be a high school junior or senior who has been accepted into a four-year degree program at a college or university. The Allaire Medalist receives the Allaire medallion and up to \$10,000 in total scholarship support for undergraduate tuition, room and board, fees, and books at his or her intended university or college.

5.5 CHAMPION (CHAMPIONSHIP ONLY)

This award celebrates the alliance that wins the final match of the Championship Playoffs.

5.6 CHAMPIONSHIP FINALIST (CHAMPIONSHIP ONLY)

This award celebrates the alliance that makes it to the final match of the Championship Playoffs.

5.7 DAIMLERCHRYSLER TEAM SPIRIT AWARD

This award celebrates extraordinary enthusiasm and spirit through exceptional partnership and teamwork.

5.8 DELPHI "DRIVING TOMORROW'S TECHNOLOGY™" AWARD

This award celebrates an elegant and advantageous machine feature. This award recognizes any aspect of engineering elegance including, but not limited to: design, wiring methods, material selection, programming techniques, and unique machine attributes. The criteria for this award are based on the team's ability to concisely describe verbally, as well as demonstrate, this chosen machine feature.

5.9 DIVISION FINALIST (CHAMPIONSHIP ONLY)

This award celebrates the alliance that makes it to the final match in its division at the Championship.

5.10 DIVISION CHAMPION (CHAMPIONSHIP ONLY)

This award celebrates the alliance that wins the final match in their division at the Championship.

5.11 ENGINEERING INSPIRATION AWARD

This award celebrates a team's outstanding success in advancing respect and appreciation for engineering and engineers, both within their school as well as their community. Criteria include: the extent and inventiveness of the team's efforts to recruit students to engineering, the extent and effectiveness of the team's community outreach efforts, and the measurable success of those efforts. This is the second highest team award *FIRST* bestows.

5.12 THE FOUNDER'S AWARD (CHAMPIONSHIP ONLY)

Each year *FIRST* presents this award to honor an organization or individual that has contributed significantly to the growth of *FIRST*.

Past winners of the Founder's Award include:

1993	Motorola, Inc.
1994	Honeywell
1995	Walt Disney World's Epcot
1996	The City of Manchester, NH
1997	Francois Castaing of Chrysler Corporation
1998	Johnson & Johnson
1999	NASA
2000	William Murphy, Founder of Cordis Corporation & Small Parts, Inc.
2001	Autodesk, Inc.
2002	John Doerr, partner, Kleiner Perkins Caufield & Byers
2003	Innovation First
2004	FedEx Corporation
2005	The LEGO Group
2006	United Technologies Corporation

5.13 GENERAL MOTORS INDUSTRIAL DESIGN AWARD

This award celebrates form and function in an efficiently designed machine that effectively achieves the game challenge.

5.14 HALL OF FAME (CHAMPIONSHIP ONLY)

FIRST Robotics created The Hall of Fame to recognize the teams that have had the most impact on *FIRST* growth. A team earns permanent Hall of Fame status by winning the Championship Chairman's Award, *the* most prestigious *FIRST* award. Unlike other Halls of Fame, the model teams in the *FIRST* Hall of Fame are not retired, but begin a new phase of participation, requiring additional activities to achieve Hall of Fame Star Status. To achieve Hall of Fame Star Status, a team must submit a Chairman's Award entry, using the same criteria as all other Chairman's Award applicants as described above in "Submission Process." These submissions need to include all activities that the team has participated in during 2007 that enhance the community's awareness of *FIRST*. Hall of Fame Chairman's Award submissions will not be included in the Regional Chairman's Award judging process.

5.14.1 DVD Submission

FIRST encourages teams to enhance each submission by creating a DVD, which should be mailed to *FIRST* headquarters, attention Sue Robinson, postmarked no later March 28, 2007. Teams are encouraged to bring a copy of the DVD and have equipment to show it in their booths at The Championship.

Congratulations to all the previous Chairman's Award winners! This year's thirty-seven (37) Regional Chairman's Award winners will vie for the one spot reserved for the 2007 winner.

5.14.2 Display Specifications

To be determined and communicated at a later date.

5.14.3 Hall of Fame Teams

THE *FIRST* HALL OF FAME

Year	Team #	Official Team Name
2006	111	Motorola & Rolling Meadows High School & Wheeling High School
2005	67	General Motors Milford Proving Ground and Huron Valley Schools
2004	254	NASA Ames Research Center/Laron Incorporated/Unity Care Group/Line-X of San Jose/PK Selective Metal Plating, Inc. & Bellermine College Preparatory
2003	103	NASA/Amplifier Research/Custom Finishers/Lutron Electronics/BAE Systems & Palisades High School
2002	175	Hamilton Sundstrand Space Systems International/The New England Air Museum/Techni-Products/Veritech Media & Enrico Fermi High School
2001	22	NASAJPL/Boeing/Rocketdyne/FADL Engineering/Decker Machine & Chatsworth High School
2000	16	Baxter Healthcare Corporation & Mountain Home High School
1999	120	NASA Lewis Research Center/TRW, Inc./Battelle Memorial Institute & East Technical High School
1998	23	Boston Edison & Plymouth North High School
1997	47	Delphi International & Pontiac Central High School
1996	144	Procter & Gamble & Walnut Hills High School
1995	151	Lockheed Sanders & Nashua High School
1994	191	Xerox Corporation & JC Wilson Magnet High School
1993	7	AT&T Bell Labs & Science High School
1992	191	Xerox Corporation & JC Wilson Magnet High School

5.15 HIGHEST ROOKIE SEED AWARD

This award celebrates the highest-seeded rookie team at the conclusion of the qualifying rounds.

5.16 IMAGERY AWARD

This award celebrates attractiveness in engineering and outstanding visual aesthetic integration from the machine to team appearance.

5.17 JOHNSON & JOHNSON - SPORTSMANSHIP AWARD

This award celebrates outstanding sportsmanship and continuous gracious professionalism in the heat of competition, both on and off the playing field.

5.18 JUDGES' AWARD

During the course of the competition, the judging panel may encounter a team whose unique efforts, performance, or dynamics merit recognition.

5.19 KLEINER PERKINS CAUFIELD & BYERS ENTREPRENEURSHIP AWARD

This award celebrates the entrepreneurial spirit. This award recognizes a team, which since its inception has developed the framework for a comprehensive business plan in order to scope, manage, and obtain team objectives. This team displays entrepreneurial enthusiasm and the vital business skills for a self-sustaining program.

5.20 MOTOROLA QUALITY AWARD

This award celebrates machine robustness in concept and fabrication.

5.21 REGIONAL FINALIST (REGIONAL ONLY)

This award celebrates the alliance that makes it to the final match of the competition.

5.22 REGIONAL WINNER (REGIONAL ONLY)

This award celebrates the alliance that wins the final match of the competition.

5.23 ROCKWELL AUTOMATION INNOVATION IN CONTROL AWARD

This award celebrates an innovative control system or application of control components to provide unique machine functions

5.24 ROOKIE ALL-STAR AWARD

This award celebrates the rookie team exemplifying a young but strong partnership effort, as well as implementing the mission of *FIRST* to inspire students to learn more about science and technology.

NOTE: This is essentially the “Chairman’s Award for Rookie teams”. We encourage, but do not require, rookie teams to enter a Chairman’s Award submission relative to this award.

5.25 ROOKIE INSPIRATION AWARD

This award celebrates a rookie team’s outstanding success in advancing respect and appreciation for engineering and engineers both within their school, as well as in their community. It is the 2nd highest honor *FIRST* bestows to a rookie team.

5.26 UNDERWRITERS LABORATORIES INDUSTRIAL SAFETY AWARD

This award celebrates the team that progresses beyond safety fundamentals by using innovative ways to eliminate or protect against hazards. The winning team consistently demonstrates excellence in industrial safety performance that shines throughout the competition from uncrating to re-pack.

5.27 XEROX CREATIVITY AWARD

This award celebrates creative design, use of a component, or a creative or unique strategy of play.

5.28 WEBSITE AWARD

The Website Award recognizes excellence in student-designed, built, and managed *FIRST* team websites. Eligible websites are scored *PRIOR* to the competition by a panel of evaluators. **Two** subcategories of awards will be given for website design:

- 7) “Website Excellence”
- 8) “Best Website”

Every submission that meets the *FIRST* website design standards of excellence will receive the Website Excellence award. Website Excellence award winners will receive an electronic certificate to include on their websites. At each Regional Competition, there will be one award

for Best Website. The overall championship Best Website award winners will be chosen from among the regional winners.

5.28.1 Submission and Deadline Information

Only team websites that are entered into firstawards.org by **11:59 p.m. EST on February 22, 2007** will be evaluated. Team websites are eligible for these awards at every regional event in which the team is competing. You must enter your website separately into each event where you want it evaluated. The websites must be completed and functioning by the date of submission. Any website found to be “down,” and not able to be viewed by the evaluators, will be disqualified at that particular event.

Any website, which in the evaluator’s opinion, contains distasteful or objectionable material will be disqualified from consideration in all events in which the website was entered. Any team whose website is disqualified will be notified by e-mail of the disqualification and the reason for it.

Only one electronic Website Excellence certificate will be awarded per team for the entire competition season. A team is eligible to win the Best Website award at multiple regional events.

5.28.2 Scoring Criteria

The following criteria will be used to evaluate the Website Awards:

5.28.2.1 General

The ideal website is a genuine reflection of the team, its participants, spirit, and goals. It should not be just a bulletin board with information accessible via a menu. It should tell an individual story and also detail how it is part of the larger *FIRST* community.

5.28.2.2 Content and Design

The content (text, pictures, music, etc.) and design of a website should work together to provide a pleasing user experience. Good content with a confusing interface, or vice versa, will not be scored as highly as a site with better balance.

5.28.2.3 Content (25 points)

Does the website:

- Clearly tell the team story and articulate its mission?
- Include recognition of sponsors and volunteers?
- Explain *FIRST* and promote its vision?
- Include helpful resources for other *FIRST* teams?
- Contain interesting non-text content such as music, sound, animation, or video?

5.28.2.4 Structure and Navigation (25 points)

- How easy is it, in general, to navigate throughout the site?
- Does it have HTML links that provide easy access to external content?
- Do links open new, separate browser windows?
- Is important information easily accessible?
- Is there a prominent link to the *FIRST* website on the home page?

5.28.2.4.1 *Visual Design (25 points)*

- Is the site engaging, and does it encourage exploration?
- Does the website:

- Communicate a visual experience reflective of the team identity?
- Use color and iconography in a consistent way?
- Use the official *FIRST* logo?
- Include photos of the team participants, volunteers, and sponsors?

5.28.2.5 Functionality and Interactivity. (25 points)

- Does the website work well?
- Does the home page load quickly?
- Do the links work throughout the site?
- Does it take into consideration those with diverse user requirements including file sizes, file formats, special access needs, (i.e. alt tags for images) and download speeds?
- Are there effective opportunities for a visitor to interact with the website?

5.28.3 Evaluating Process

Each website submitted for consideration will be reviewed by a panel of evaluators prior to each competition.

There will be no on-site interviews. If the evaluators have questions about a particular website, they may contact the team via email prior to the competition to resolve their questions.

Websites receiving a score of 80% or more, but not winning the Regional Best Website Award, will receive the Website Excellence Award.

5.28.4 Award Presentation

Each team that wins Best Website at a competition will receive an award at that event.

Teams that earn the Website Excellence award will receive an e-mailed, electronic certificate to place on their websites following the Championship.

5.29 2007 WEBSITE AWARD SCORING SHEET

Event: _____

Team Numbers	#	#	#	#	#
Content (25 points)					
<input type="checkbox"/> Does the website clearly tell the team story and articulate their mission? <input type="checkbox"/> Does the website include recognition of sponsors and volunteers? <input type="checkbox"/> How well does the site explain <i>FIRST</i> and promote its vision? <input type="checkbox"/> Does the website include helpful resources for other <i>FIRST</i> teams? <input type="checkbox"/> Does the website contain interesting non-text content such as music, sound, animation, or video?					
Structure and Navigation (25 points)					
<input type="checkbox"/> Is it easy to navigate through the site? <input type="checkbox"/> Does it have HTML links that provide easy access to external content? <input type="checkbox"/> Is important information easily accessible? <input type="checkbox"/> Is there a prominent link to the <i>FIRST</i> website? <input type="checkbox"/> Do links open new, separate browser windows?					
Visual Design (25 points)					
<input type="checkbox"/> Does the website communicate a visual experience reflective of the team identity? <input type="checkbox"/> Is the site engaging and does it encourage exploration? <input type="checkbox"/> Does the site use color and iconography in a consistent way? <input type="checkbox"/> Does the website homepage use the official <i>FIRST</i> logo? <input type="checkbox"/> Does the website include photos of the team participants, volunteers, and sponsors?					
Functionality and Interactivity (25 points)					
<input type="checkbox"/> Does the site work well? <input type="checkbox"/> Does the homepage load quickly? <input type="checkbox"/> Do the links work throughout the site? <input type="checkbox"/> Does it take into consideration those with diverse user requirements including file sizes, file formats, special access needs, (i.e., alt tags for images), and download speeds? <input type="checkbox"/> Are there effective opportunities for a visitor to interact with the website?					

5.30 WOODIE FLOWERS AWARD

The Woodie Flowers Award celebrates effective communication in the art and science of engineering and design. Dr. William Murphy and Small Parts, Inc. founded this prestigious award in 1996 to recognize mentors who lead, inspire, and empower using excellent communication skills.

FIRST will recognize one adult team member at each of the thirty-seven (37) Regional Competitions as a Woodie Flowers Finalist Award (WFFA) winner. These finalists will be combined with past years' WFFA winners, and one will be judged to receive the Woodie Flowers Award at the 2007 Championship in Atlanta.

Past winners of this award also include:

1997	Elizabeth Calef	Teacher, Bridgewater-Raynham Regional High School
1998	Michael Bastoni	Teacher, Plymouth North High School
1999	Ken Patton	Engineer, GM Powertrain
2000	Ms. Kyle Hughes	Teacher, OSMTech Academy
2001	William Beatty	Beatty Machine & Manufacturing Company
2002	David Verbrugge	Engineer, GM Proving Ground
2003	Andy Baker	Engineer, Delphi Automotive Systems
2004	David Kelso	Teacher, Central High School
2005	Paul Copioli	Staff Engineer, FANUC Robotics America
2006	Rob Mainieri	Teacher, The Preuss School at UCSD

5.30.1 Award is Students' Choice

High school students on a *FIRST* Robotics team will choose one adult team member as their WFFA candidate. They will describe how this mentor has given them the best understanding of the challenges, opportunities, and satisfaction involved in the discipline of engineering and design. Professor Flowers will lead the past Championship Woodie Flowers Award (WFA) winners as they judge and select the 2007 Finalists and Championship winner based on student essays.

Team mentors should direct their students to the entry site and let the student nominators decide who to nominate. Adults can help edit, but this must be a student-led effort, since any team mentor is eligible. Authors must be clearly identified as high school students in the submission paperwork.

5.30.2 Spirit of the Award

Two aspects of this award are important. The accomplishments in communication by the mentor are essential. Also important is the student's ability to communicate clearly and concisely through their written nomination. This award recognizes an individual who has done an outstanding job of motivation through communication while also challenging the student body to be clear and succinct in recognizing the value of communication.

In the spirit of recognizing additional deserving mentors, past WFFA winners are not eligible to win the Regional award again. These previously recognized mentors are only eligible to win the Championship WFA.

5.30.3 Judging Criteria

Each FRC team may nominate one candidate to be a WFFA winner. This candidate must be an adult mentor on the same team as the student nominator(s). Students may also re-nominate one of their team's past WFFA winners by submitting a new essay for this past Finalist to be eligible for the Championship WFA. Judging criteria is based on the team's description of how the mentor inspired each member of the team in some or all of the following ways:

- Level of student participation
- Creativity of effort
- Clear explanation of mathematical, scientific, and engineering concepts
- Demonstration of enthusiasm for science and engineering
- Encouragement to work on projects as a team effort
- Inspiration to use problem-solving skills
- Inspiration to become an effective communicator

Each *FIRST* team completes a product development cycle as it designs a concept, develops a prototype, and builds and debugs a unique machine. This requires teamwork, attention to detail, scheduling, and hard work. The award-winning essay should answer this question; "How did the candidate inspire your team throughout this process?" If the essay best describes how this individual excels above all others as he or she inspires the team, then that mentor truly deserves to be recognized with the award that honors Professor Woodie Flowers and his contribution to engineering, education, and communication.

5.30.4 Entry Requirements

Students enter their candidate at the Woodie Flowers Award entry web page: www.firstawards.org/ They enter team and candidate information, reference information, and a six hundred-word (600) essay, written in English. Teams may also add up to six (6) pictures, totaling no more than 1.0 Mb. of memory. This essay should be a team effort and will stand alone as the team's entry to award their candidate the deserved recognition.

For students to re-nominate a past WFFA winner (one per team) for the WFA, they must write a new six hundred word essay.

As in the past, teams may only submit at one Regional competition for judging. Teams submitting for both the Chairman's Award and the Woodie Flowers Award should note that both awards are judged at the same event. Students working on the Woodie Flowers Award submission and those team members working on the Chairman's Award submission must coordinate to select the best event for the team.

5.30.5 Submission Deadline

The Woodie Flowers Award entries are **due on Thursday, February 22nd at 11:59 p.m. EST.**

5.30.6 Entry Process

The Woodie Flowers Award submission is submitted on-line at www.firstawards.org/. Nomination entry directions are listed on this site. This site will be available beginning January 16th, 2007 at noon EST.

Student nominators must follow the directions listed on the screen. Each team can only submit one WFFA candidate for this award. Teams can also enter an essay for one of their team's past WFFA winners (if applicable) in order to make them eligible for the Championship WFA. As the student nominator fills out the required information, he/she will choose their selected

regional.

Student nominators can easily enter information, save it, and return to the site to edit their entry information until they are ready to submit it for judging. All entries will be final on Thursday, February 22nd at 11:59 p.m. EST (midnight). No entries will be accepted or altered after this date.

Students will go to the website to enter information in the following fields:

Team Number

Candidate Information:

First Name, Middle Initial, Last Name

Address, City, State, zip code

Employer

Occupation

Position on team

High School Student Nominator's information: (Student recommending candidate)

First Name, Last Name

Phone Number

High School

E-mail Address

Position on Team

Year in School (9th, 10th, 11th, 12th)

Adult Reference (On the same team)

First Name, Last Name

Phone Number

E-mail Address

Position on Team

Adult Reference (Any FIRST affiliation)

First Name, Last Name

Phone Number

E-mail Address

Regional Selection (Team must attend this Regional)

Upload Pictures (Up to 6, no more than 1.0 Mb total)

Essay (600 words or less) - The students will see a quote from Dr. Murphy and/or Woodie about the value of concise and clear writing. Once candidates' information and essays are submitted, they are sorted and posted on a private, password-protected site where only the Judges can read the entries. Each Regional will have its candidates listed and the Judges will review the Prior Regional Woodie Flowers Award Winners

5.30.7 Prior Regional Woodie Flowers Award Winners

A team may refresh the submission of any past WFFA winner on their team for their eligibility to win the Championship WFA. Only one past year WFFA winner per team can be eligible for the

Championship WFA. Student nominators will not be able to edit the original submission but can refresh it by adding a new 600-word (maximum) essay to make the submission current. Past winners without a new essay will not be eligible for the WFA in 2007.

Judges will read only the new essay.

Students nominators who entered an essay for a past year WFFA winner and for a 2007 WFFA winner will be asked to pick between one of the two mentors to be their team's Championship WFA candidate. Each *FIRST* team can have a maximum of one candidate for the Championship WFA.

5.31 FIRSTAWARDS.ORG SITE

FIRST will once again be using www.firstawards.org/ as a submission site for the Regional Chairman's Award, Hall of Fame, the Woodie Flowers Award and the Website Award. The *FIRST*awards.org site will open for submissions at noon EST on January 16, 2007 and close for all submissions on Thursday, February 22, 2007 at 11:59PM EST. The submission requirements for each award are listed in the section for the specific award.

Teams should carefully read the following information about this site before proceeding.

5.31.1 Formatting

Entries cannot contain any formatting only plain text. The only formatting supported is paragraph spacing by way of the 'return' key.

5.31.2 Accounts

Teams must register for a new firstawards.org account every year. A team's TIMS account and their firstawards.org account are not the same. Teams can only have one firstawards.org account. There are not separate logins for Chairman's and WFA entries.

5.31.3 Verification of Submission

Teams should always log in to the firstawards.org site to verify the content and the submission date of their entry after it has been submitted. For Chairman's, Hall of Fame, Rookie All Star and Woodie Flowers Award entries, teams should print a copy of the submission and bring it with them to the Regional Event. NASA Grant teams should download a copy to have should NASA request it. NASA does have access to this site, but in prior years some entries have not been completed successfully or the team did not check the NASA box and were required to supply a copy to NASA.

Section
6

THE ARENA



TABLE OF CONTENTS

6 THE ARENA.....	2
6.1 OVERVIEW	2
6.1.1 Dimensions and Tolerances.....	2
6.2 PLAYING FIELD.....	4
6.2.1 Boundaries and Markings	4
6.2.2 The RACK.....	5
6.3 GAME PIECES.....	6
6.3.1 RINGERS.....	6
6.3.2 KEEPERS	6
6.3.3 SPOILERS	6
6.4 ALLIANCE ZONES.....	7
6.4.1 Boundaries and Markings	7
6.4.2 Player Stations.....	7
6.4.3 The CHUTE	7
6.5 DRAWING NOTES.....	8

6 THE ARENA

6.1 OVERVIEW

The following sections of the manual describe the arena, game, robots and tournament structure used in the 2007 *FIRST* Robotics Competition. Please be sure to read and thoroughly understand Sections 6, 7, 8, and 9 to ensure the best opportunity for success during the competition season.

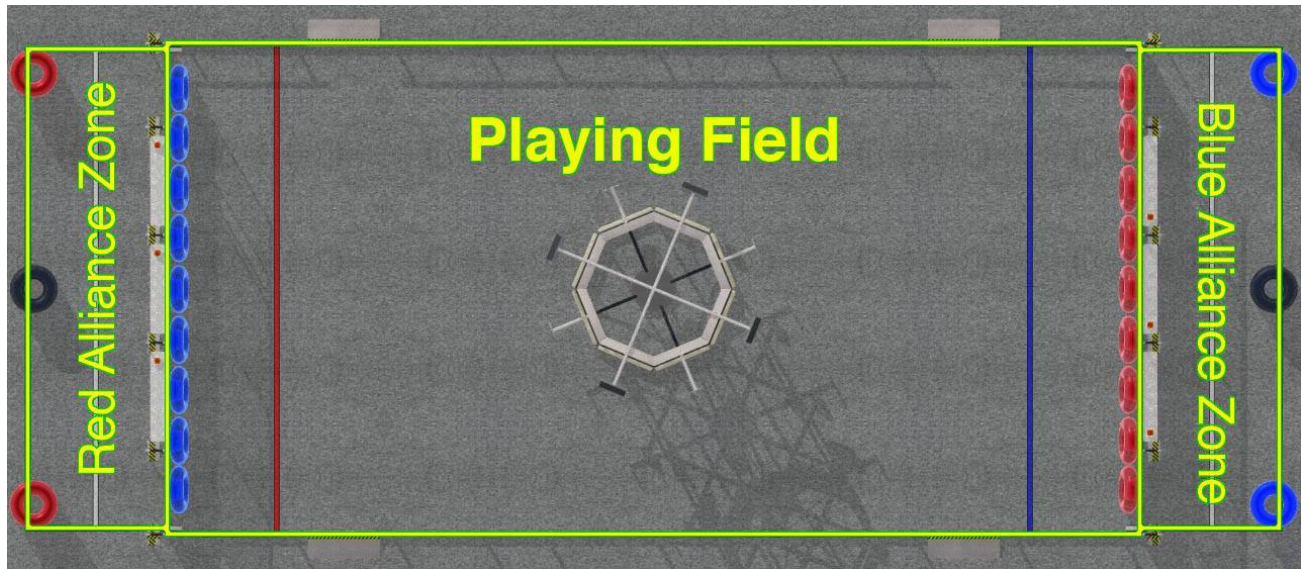

Note: The illustrations in this section of the manual are for a general visual understanding of the field only. Teams should refer to the drawings for exact dimensions and field construction.

The Playing Field is a 26 by 54-foot rectangular area in which the ROBOTS compete. The Red and Blue Alliance Zones are rectangular areas, each consisting of three team stations, which are located outside of the ends of the Playing Field. The three teams that make up each Alliance play the game from these zones.

The specifications below are for the *FIRST* playing fields used in competition. These fields are welded aluminum, which are built to withstand rigorous play and damage from frequent shipping. Precise specifications and construction details of the field elements can be found on the *FIRST* web site at www.usfirst.org/frc/2007/officialdrawings.html. Note that the web site also contains drawings for suggested low-cost versions of the important field elements that teams can build for their own use during the construction and testing of the ROBOT. These drawings can be found at www.usfirst.org/frc/2007/teamdrawings.html.

6.1.1 Dimensions and Tolerances

The exact dimensions and construction details of the fields are contained on the official field drawings. The relevant drawings include:

2007 FRC DRAWINGS			
TITLE LINE 1	TITLE LINE 2	DWG NO.	SHEET/S
2007 Field	Layout and Marking	T07-0100	1 Sheet
2007 Field Rack	Fabrication	G07-0001	3 Sheets
2007 Field Rack	Weldments	G07-0002	1 Sheet
2007 Field Rack	Sub-Assemblies	G07-0003	1 Sheet
2007 Field Rack	Assembly	G07-0004	1 Sheet
Drivers Station Panel	Fabrication	F05-0001	1 Sheet
Drivers Station Panel	Assembly	F05-0002	1 Sheet
Drivers Station Support	Fabrication	F05-0003	1 Sheet
Drivers Station Support	Assembly	F05-0004	1 Sheet
Corner Support	Fabrication	F05-0005	1 Sheet
Corner Support	Assembly	F05-0006	1 Sheet
Field, Rail	Fabrication & Assembly	F05-0007	1 Sheet
Field, Rail / Gate	Fabrication & Assembly	F05-0008	1 Sheet
Field, Top Rail	Fabrication & Assembly	F05-0011	1 Sheet
Field Plastic Panel	Fabrication	F05-0012	1 Sheet
Field Outrigger	Fabrication & Assembly	F05-0013	1 Sheet
Hinge Insert	Fabrication	F05-0015	1 Sheet
Field Corner Panel	Fabrication	F05-0016	1 Sheet
Field Corner Panel	Assembly	F05-0017	1 Sheet
Field Corner Top Rail	Fabrication & Assembly	F05-0018	1 Sheet
Field Entry Ramp	Fabrication & Assembly	F05-0020	1 Sheet
Field Gate Hanger	Fabrication	F05-0021	1 Sheet
Field Trip Guard	Fabrication	F07-0023	1 Sheet
2007 Vision Target	Fabrication & Assembly	F02-0202	2 Sheets

Where surfaces are indicated as flush, expect variations as much as 1/4 inch. This is not considered abnormal and is part of the game challenge. The reasons for these variations are numerous; different arenas are manufactured at different sites, set up by different volunteers, and undergo different temperature extremes. Volunteers and *FIRST* staff at each competition site will do their best to make the Arena and its elements as close to nominal as reasonably possible.

6.2 PLAYING FIELD

Note: The official Playing Field description, layout, dimensions and parts list are contained in the “2007 Arena Layout and Marking” Drawing. Diagrams and dimensions below are for illustrative purposes only.

6.2.1 Boundaries and Markings

The carpeted Playing Field is 26 feet 8 inches by 54 feet, bounded by two Alliance Station Walls and a Guardrail System.

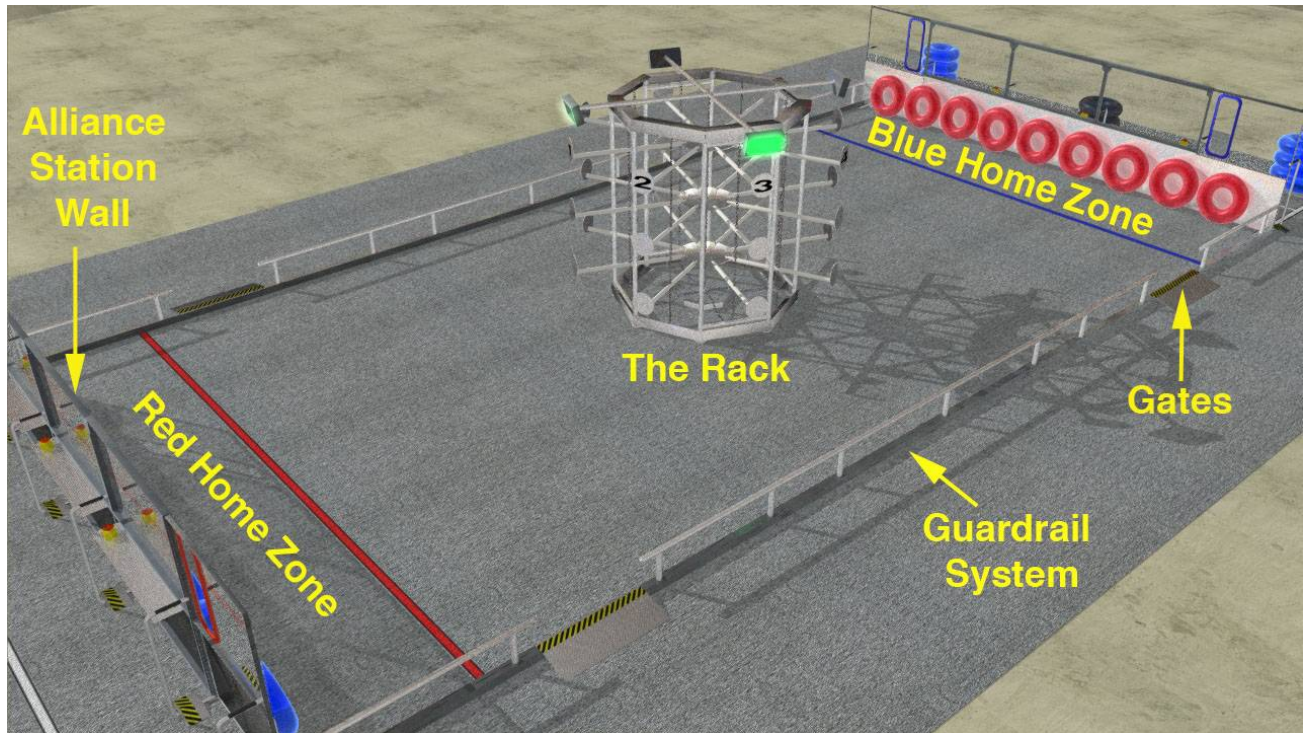

The Alliance Station Wall is 6-1/2 feet high. The entire Alliance Station Wall is 26 feet 8 inches wide, centered on the ends of the field. The wall is composed of a 3-foot high base of diamond plate aluminum topped with a 3-1/2-foot high transparent acrylic panel.

The Guardrail System is a 20-inch high horizontal pipe with vertical supports mounted on a 3" aluminum angle. A shield is attached on the field side of the Guardrail system, extending from the floor to the top of the guardrail, and running the length of the guardrail. The Guardrail System defines the borders of the Playing Field except where it is bounded by the Alliance Station Wall.

Four gates in the Guardrail System allow easy access to the Playing Field for placement and removal of ROBOTS. The gates are four feet wide and are located in each quadrant of the field. The gates are closed and shielded during game play.

A HOME ZONE is located at each end of the field. The HOME ZONE is the 8 foot by 26 foot 8 inch area bordered by the diamond plate wall of the Alliance Station, the polycarbonate walls of the playing field, and a colored line on the playing field. This line is made of a two-inch wide strip of gaffers tape. The HOME ZONE for each ALLIANCE is located at their end of the field, and the gaffers tape is colored red or blue to indicate to which ALLIANCE the HOME ZONE belongs. The tape is considered part of the HOME ZONE. Each element of the HOME ZONE border is projected vertically upwards when determining if an object is within the zone.

6.2.2 The RACK

The center of the Playing Field is occupied by the main scoring structure, known as the “RACK.” ROBOTS hang GAME PIECES on the “SPIDER LEGS” of the RACK to SCORE the LEGS for their ALLIANCE.

The RACK is an octagonal framework made of 2 inch OD aluminum pipe. The structure measures approximately 10 feet tall, and eight feet in diameter (face to face).

To constrain the motion of the RACK, the structure is connected by a set of loose chains to a small platform located at the center of the field. The platform is firmly attached to the floor of the Playing Field. The slack in the chains connecting the structure to the platform permit the RACK to translate approximately one foot in any direction, and freely rotate around the platform.

Four vision system targets are located at the top of the RACK, at 90-degree intervals around the periphery. The vision system targets are illuminated panels measuring 8 by 16 inches, with the top of the panel approximately ten feet from the floor. Each panel is located directly above the ends of the set of “SPIDER LEGS” beneath them. The panels are back-lit by a series of cold cathode tubes mounted in an aluminum enclosure. The vision system targets are illuminated during the entire game. The power cable for the target lights is suspended above the RACK and drops down to the power supply located at the top center of the RACK. ROBOTS are not to interact or interface with the power cable by any means. Doing so will result in disqualification of the offending ROBOT.

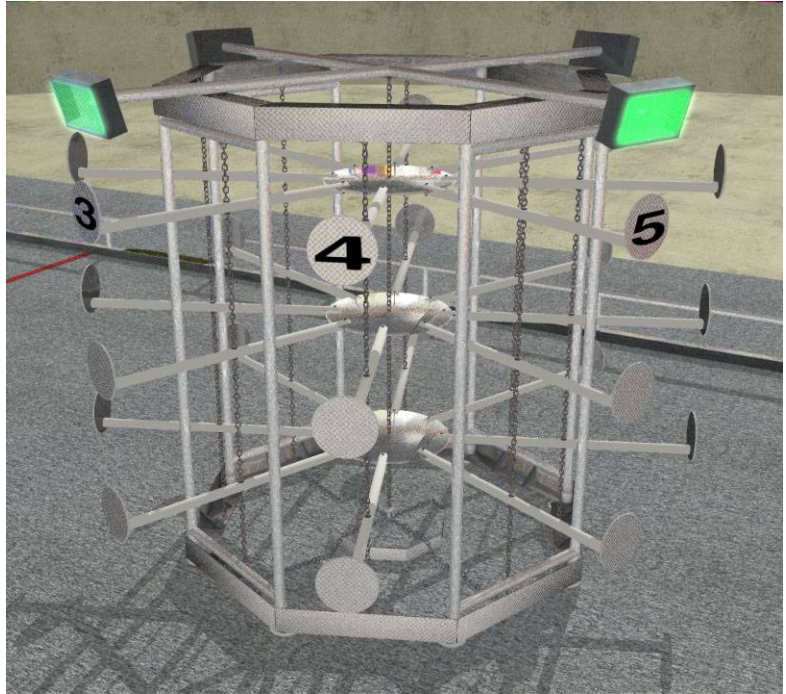

A series of chains are suspended from the top edges and center of the structure. The chains support three “SPIDERS” upon which the GAME PIECES may be hung. The spiders are located at approximately 24 inches, 58 inches, and 92 inches above the floor. Each SPIDER is made of a central disk of 1/2 inch polycarbonate, two feet in diameter, from which eight 2-inch SCH 40

PVC “SPIDER LEGS” extend. As it is hanging from the chains the entire SPIDER assembly, and each SPIDER LEG within that assembly, can move within a large range of horizontal motion.

The 24 SPIDER LEGS constitute the set of scoring locations on the RACK, on which the GAME PIECES can HANG. Each five-foot long SPIDER LEG is attached to the central disk of the SPIDER with a loose pivoting joint that allows it to freely rotate in the horizontal plane. The end of the leg has a retaining plate, known as the SPIDER FOOT, made of a 10-inch diameter disk of diamond plate aluminum. The SPIDER FOOT prevents GAME PIECES from falling off once they are placed on the SPIDER LEG. Each SPIDER LEG is designed to allow one or two, but no more, GAME PIECES to HANG from it in permissible positions. A short length of flexible rubber hose, known as the STINGER, is attached to the back of the SPIDER FOOT. The STINGER helps prevent GAME PIECES from being knocked out of position once they are HANGING.

6.3 GAME PIECES

The GAME PIECES are toroidal tubes made of inflatable plastic. When inflated, each GAME PIECE is approximately 32 inches across the outer diameter. Each toroid has an inner diameter of approximately 13 inches, and a height of approximately 9-1/2 inches. There are three types of GAME PIECES used in the game.

6.3.1 RINGERS

The “RINGERS” are made of translucent plastic. They are colored red or blue, with no other identifying markings. Each ALLIANCE will start the game with 18 RINGERS of their color. Nine of the RINGERS will be located in the ALLIANCE ZONE, and nine of the RINGERS will be set up against the Alliance Station Wall at the far end of the playing field.



6.3.2 KEEPERS

The “KEEPERS” are similar to the RINGERS, except that a broad white band inscribed with the *FIRST* logotype is imprinted on the outer circumference of the toroid. Each ALLIANCE will start the game with three KEEPERS, one per ROBOT. A KEEPER can only be SCORED during the AUTONOMOUS PERIOD.

6.3.3 SPOILERS

“SPOILERS” are similar in size and shape to the other tubes, except that they are made of opaque black plastic. Each ALLIANCE will start the game with two SPOILERS located in their ALLIANCE ZONE.

6.4 ALLIANCE ZONES

The two ALLIANCE ZONES are located at either end of the field, behind the Alliance Station Walls. Each ALLIANCE ZONE is a 26' 8" x 8' area, and includes three identical player stations. All team members stand behind the Alliance Station Wall during the match, where they can move freely within the Alliance Zone.

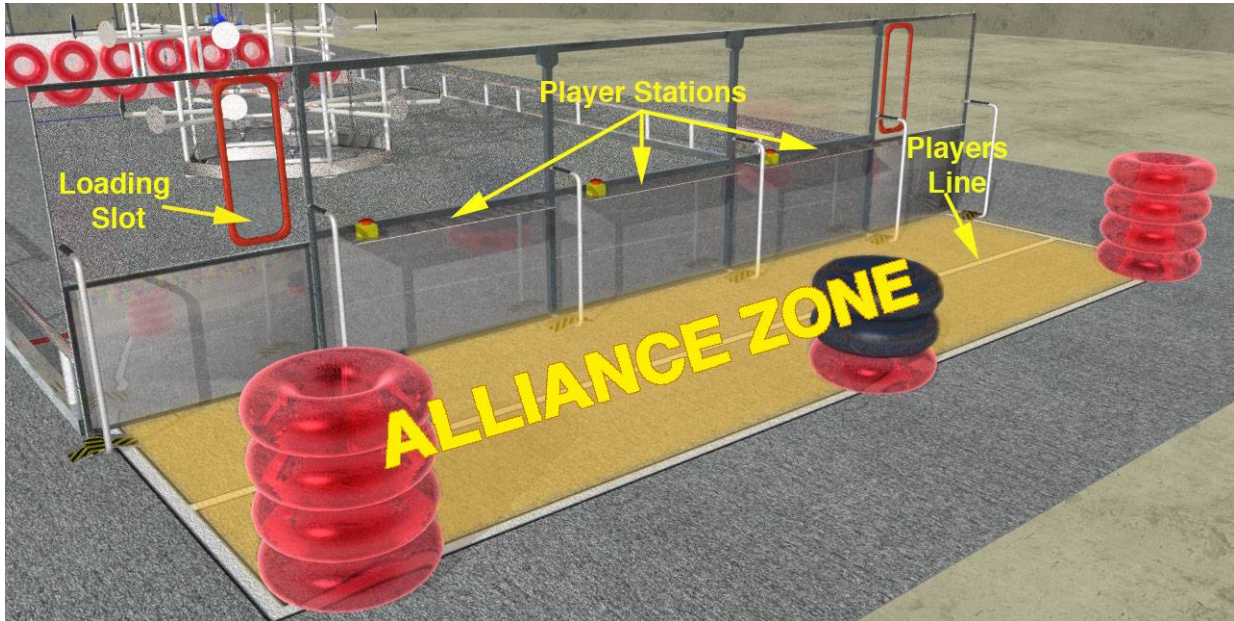

6.4.1 Boundaries and Markings

Each ALLIANCE ZONE shares the Alliance Station Wall with the Playing Field and has its outer and back edges marked on the carpet with white gaffer tape. The ALLIANCE ZONE extends eight feet back from the Alliance Station Wall, and is the width of the field. Four feet from the Alliance Station Wall, the Players Line is marked on the carpet with a two-inch wide white gaffers tape. The ALLIANCE ZONE includes the area behind the PLAYER'S LINE. The tape boundaries are considered "in" the Alliance Zone.

6.4.2 Player Stations

Attached to the Alliance Station Wall are three aluminum shelves to support the alliance robot control systems of the three teams. The support shelf measures approximately 60 inches wide by 12 inches deep. There is a 4-1/2-foot long by two-inch wide strip of Velcro tape ("loop" side) along the center of the support shelf that may be used to secure the ROBOT controls and Operator Interface. Each setup location includes a competition cable, which attaches to the "Competition Port" of the Operator Interface. This cable provides power for the team's Operator Interface and controls communications with the ROBOT. Emergency Stop (E-Stop) buttons for each team are located on the left end of each Player Station shelf.

6.4.3 The CHUTE

The CHUTE is an opening at either side of the Alliance Station Wall, through which student team members may pass RINGERS and SPOILERS to the ROBOTS and/or enter them onto the field. The CHUTE is located in the upper portion of the Alliance Station Wall, and is approximately 31 inches tall by 9 inches wide. The CHUTE is outlined with a colored rim to aid visibility (either red

or blue, to match the corresponding Alliance Zone at that end of the field). RINGERS and SPOILERS may be passed from the ALLIANCE ZONE through the CHUTE and on to the Playing Field. Four bungee cords are positioned at the edges of the CHUTE that can hold GAME PIECES in position in the CHUTE so that they may be retrieved by passing ROBOTS.

6.5 DRAWING NOTES

The materials required to construct the “*Rack 'n' Roll*” playing field are commonly available from multiple sources. In most cases, teams should be able to obtain all the materials required to construct a practice field from local hardware stores, home improvement centers, and/or industrial supply resources. If all materials are not available through your local outlets, some sources for field construction materials are listed below:

- Supplier for the Gaffer’s Tape for field markings: Go to <http://www.tapemonster.com>
 - Order Shurtape PC-628 2” x 60 yds Red Gaffers Tape for the line that marks the Red Alliance End Zone. It is ~\$8 per roll.
 - Order Shurtape PC-628 2” x 60 yds Blue Gaffers Tape for the line that marks Blue Alliance End Zone. It is ~\$8 per roll.
 - Order Shurtape PC-628 2” x 60 yds White Gaffers Tape for the lines that mark the Team Zones. It is ~\$8 per roll.

- Supplier for plastics & HDPE: Plastic Supply Inc., located in Manchester, NH. Go to <http://www.plasticsupply.com/> or call 800-752-7759 or 603-669-2727 (Fax 603- 668-1691; Email: plasticsupply@conversent.net). Identify yourself as a *FIRST* team and give them your team number.



THE GAME

TABLE OF CONTENTS

7 THE GAME.....	2
7.1 GAME OVERVIEW	2
7.2 THE GAME.....	2
7.2.1 Definitions	2
7.2.2 Match Format.....	3
7.3 RULES	3
7.3.1 Safety.....	3
7.3.2 Game Play	4
7.3.3 Robot Operations.....	7
7.3.4 Team Member Actions	10
7.3.5 Referee Interactions.....	11
7.3.6 Scoring.....	11

7 THE GAME

7.1 GAME OVERVIEW

Rack 'n' Roll is a game played on a field as illustrated in the figure below. Two ALLIANCES, one red and one blue, composed of three teams each, compete in each match. The object of the game is to attain a higher score than your opponent ALLIANCE by placing toroidal GAME PIECES on the central goal structure (the RACK), and/or by having ROBOTS in their HOME ZONE and not in contact with the playing field at the end of the match. The point values for each of those actions are explained below.

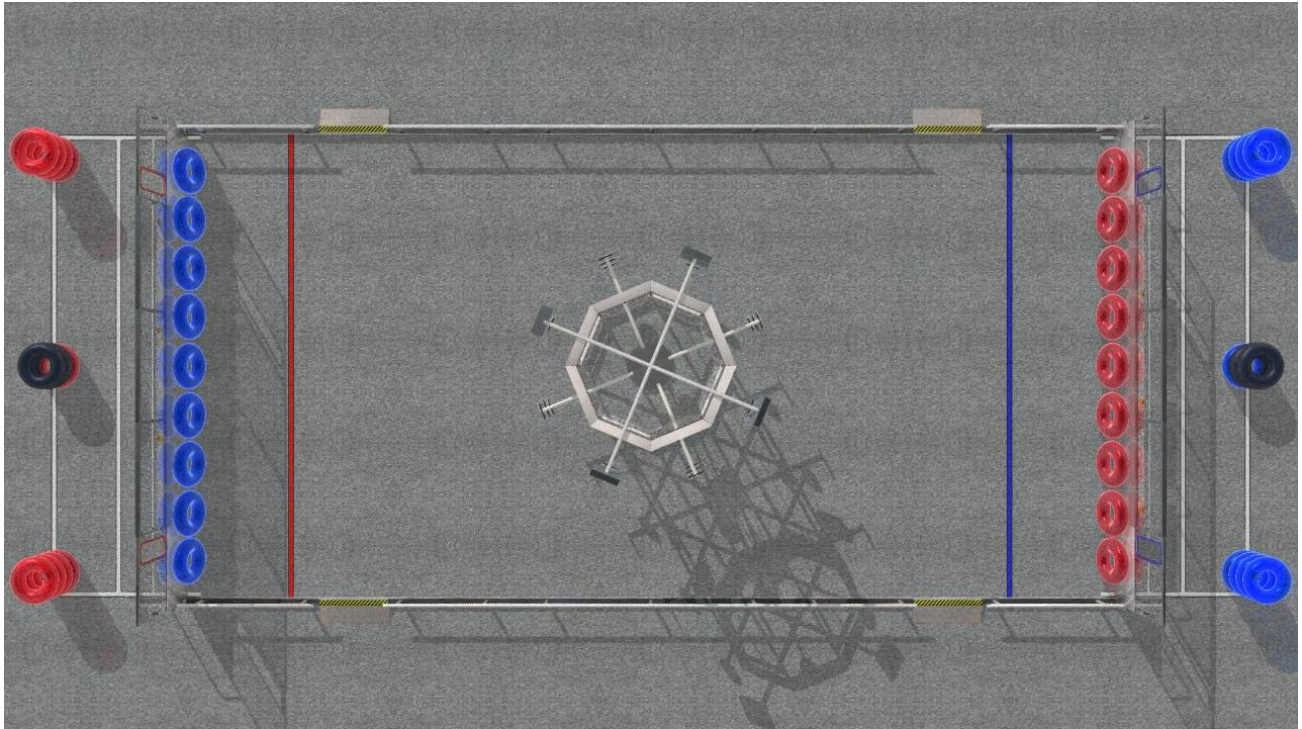

Note: The illustrations in this section of the manual are for a general visual understanding of the field and game only. Teams should refer to the drawings for exact dimensions and field construction.

7.2 THE GAME

7.2.1 Definitions

ALLIANCE: a set of three *FIRST* Robotics Competition teams that work together during a match to play Rack 'n' Roll against an opposing ALLIANCE. ALLIANCES are identified during the match by their assigned color, either red or blue.

BUMPER ZONE: the volume between two planes parallel to the floor, the lower being 2-1/2 inches above the floor, and the upper being 8-1/2 inches above the floor. The BUMPER ZONE is defined with respect to the ROBOT when in PLAYING CONFIGURATION.

HANGING: a GAME PIECE is considered HANGING if its' weight is fully supported by a SPIDER LEG and it has been released by the POSSESSING ROBOT. A GAME PIECE is not considered HANGING if it is supported by the SPIDER FOOT.

POSSESSION: a GAME PIECE is considered to be in the POSSESSION of a ROBOT if it is being fully supported by the ROBOT, or if the ROBOT is controlling the position and movement of the GAME PIECE. A GAME PIECE on the floor is considered to be in the POSSESSION of a

ROBOT if it contacts the ROBOT at more than a single point (e.g. the ROBOT has a concave "plow" feature that is used to push the GAME PIECE in a controlled manner).

ROBOT: anything that has passed ROBOT inspection that a TEAM places on the field prior to the start of a match.

ROW: a set of SPIDER LEGS that are SCORED for the same ALLIANCE and are adjacent and aligned either vertically or horizontally.

SCORED: a SPIDER LEG is considered SCORED if one or two GAME PIECES are HANGING on it in a legal configuration. Based on the particular configuration of the GAME PIECES (as defined in Rule <G57>). The SPIDER LEG may be considered SCORED for the "Red" ALLIANCE, for the "Blue" ALLIANCE, or "Null".

SINGLETON: a SPIDER LEG that has been SCORED, but is not part of any ROW.

TEAM: four representatives from a registered *FIRST* Robotics Competition team that interact with their robot and their ALLIANCE partners to play Rack 'n' Roll. The positions on the TEAM include:

COACH: a student or adult mentor designated as the team advisor during the match and identified as the person wearing a "COACH" pin or button. There is one COACH per TEAM.

DRIVER: a pre-college student team member responsible for operating and controlling the ROBOT. There are two DRIVERS per TEAM.

HUMAN PLAYER: a pre-college student team member designated as the only team member permitted to enter GAME PIECES onto the field. There is one HUMAN PLAYER per TEAM.

7.2.2 Match Format

A match is 2 minutes and 15 seconds long. A brief AUTONOMOUS PERIOD starts each match in which the ROBOTS are controlled by pre-programmed instructions. The AUTONOMOUS PERIOD is followed by the TELEOPERATED PERIOD during which the DRIVERS assume control of the robot. There may be a short pause between AUTONOMOUS PERIOD and the start of the TELEOPERATED PERIOD as the player's stations are activated. The final portion of the TELEOPERATED PERIOD is known as the END GAME. The END GAME is played as a continuation of the TELEOPERATED PERIOD, except ROBOTS are not permitted in their opponent's HOME ZONE.

7.3 RULES

7.3.1 Safety

<S01> If at any time a ROBOT'S operation or design is deemed unsafe by the head referee, it will receive a 10-point penalty and be disabled for the remainder of the match. If the safety violation is due to the ROBOT design, the head referee has the option to not allow the ROBOT back onto the field until the design has been corrected. Examples of unsafe operation include uncontrolled motion that cannot be stopped by the drivers, throwing GAME PIECES into the audience etc.

<S02> HUMAN PLAYERS, DRIVERS, and COACHES may not directly contact any ROBOT at any time during the match. Illegal contact will result in the disabling of the TEAM'S ROBOT for the remainder of the match.

<S03> ° ROBOTS cannot break the plane of the CHUTE.
° HUMAN PLAYERS cannot break the plane of the CHUTE.

Violating this rule may result in the disabling of the ROBOT for the remainder of the match.

<S04>E-Stop - An Emergency Stop (E-Stop) button is located in each TEAM'S Player Station. Pressing an E-Stop button will cause the TEAM'S ROBOT to be disabled for the remainder of the match. The E-Stop buttons are intended for remote shut down during a match in the event of safety hazards and will not otherwise affect match score or duration. Any team member, including COACHES, may press the E-Stop button. If a team member stops a ROBOT by pressing the E-Stop button, the ROBOT will not be re-enabled for the remainder of the match.

7.3.2 Game Play

7.3.2.1 Game Periods

<G01> AUTONOMOUS PERIOD - The AUTONOMOUS PERIOD is the 15-second period at the start of the match. Human control of the ROBOT is not permitted at this time. The ROBOTS may react only to sensor inputs and commands programmed into the onboard control system. All ROBOT safety rules are still applicable during AUTONOMOUS PERIOD. The AUTONOMOUS PERIOD ends when the field timer displays zero seconds left in the period.

<G02> TELEOPERATED PERIOD - At the beginning of the 2-minute TELEOPERATED PERIOD Alliance Station controls are activated and DRIVERS then begin to remotely control their ROBOTS. The DRIVERS continue to teleoperate their ROBOTS for the remainder of the match. The TELEOPERATED PERIOD ends when the field timer displays zero seconds, which also indicates the end of the match.

<G03> END GAME - The final 15 seconds of the TELEOPERATED PERIOD is called the END GAME. During this period, no ROBOT may be in an opposing ALLIANCE HOME ZONE. The intent of this period is to permit ALLIANCES to attempt to score bonus points without undue interference. An audio signal will sound five seconds before the start of the END GAME period, and again at the start of the END GAME period.

7.3.2.2 Starting Conditions

<G04> KEEPER locations - Each ROBOT may start the match in POSSESSION of one KEEPER. The KEEPER does NOT need to be contained within the ROBOT'S starting volume, however it must be in contact with the ROBOT and be entirely within the HOME ZONE. The head referee will require that KEEPERS that do not meet these criteria be removed from the game. It is the responsibility of the head referee to verify that this rule is satisfied prior to the start of the match.

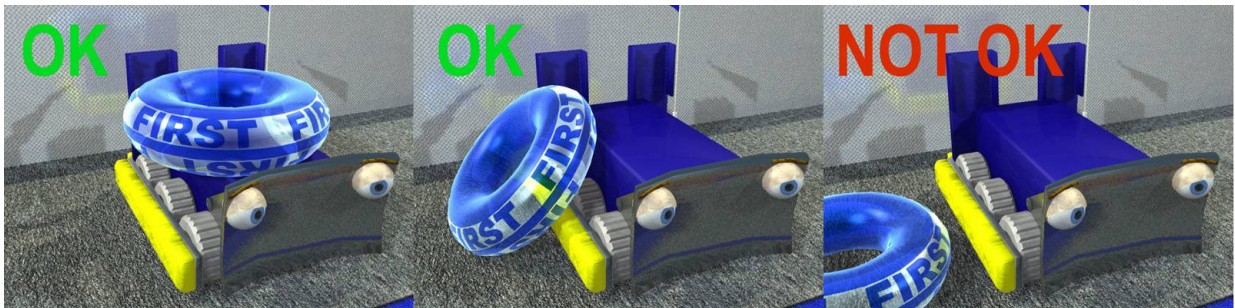

- <G05>** RINGER locations - Each ALLIANCE plays Rack 'n' Roll with 18 RINGERS. Prior to the start of the match, nine RINGERS are lined up along the width of the Alliance Station Wall of the opposing ALLIANCE. These RINGERS are resting on the floor, and lean against the Alliance Station Wall at the far end of the field. An additional nine RINGERS are placed in stacks at the back edge of the ALLIANCE ZONE of the corresponding ALLIANCE. See Section 6.4 for an illustration of the location of these stacks.
- <G06>** SPOILER locations - Each ALLIANCE plays Rack 'n' Roll with two (2) SPOILERS. Prior to the start of the match, the SPOILERS are placed in the center stack of GAME PIECES at the back edge of the ALLIANCE ZONE. See Section 6.4 for an illustration of the location of these stacks.
- <G07>** Center RACK position - After all six ROBOTS are in their starting positions and the DRIVERS, COACHES and HUMAN PLAYERS are in the ALLIANCE ZONE, the RACK will be moved (translated and/or rotated) to an arbitrary position so that the center of the RACK is within a 3 foot radius of the playing field center but the exact location and orientation of the RACK is unpredictable. After this point in time no ROBOT may be moved or repositioned until the match starts.

7.3.2.3 Match Play

- <G08>** Obtaining GAME PIECES - ROBOTS may obtain GAME PIECES via any of the following methods:
- Accepting a KEEPER prior to the start of the match as detailed in Rule <G04>
 - Picking up RINGERS from the opposing ALLIANCE HOME ZONE that were placed there prior to the start of the match
 - Grasping RINGERS or SPOILERS that have been placed in the CHUTE by the HUMAN PLAYER
 - Picking up RINGERS or SPOILERS from the playing field surface
 - Removing a SPOILER from a HANGING position on the RACK
- <G09>** POSSESSION - ROBOTS may only have 1 (one) GAME PIECE in their POSSESSION at any time during the match. A 10-point penalty will be assessed for each infraction. Inadvertent bulldozing of GAME PIECES while the ROBOT moves around the field is allowed. Controlled "herding" of a single GAME PIECE lying on the floor is permitted as long as no other GAME PIECE is in the POSSESSION of the ROBOT. Herding of multiple GAME PIECES, or herding of a GAME PIECE on the floor while in POSSESSION of another GAME PIECE is not permitted (as this would be considered POSSESSION of more than one GAME PIECE). GAME PIECES may fall on to a ROBOT during the course of normal game play (e.g. a RINGER falls on a ROBOT while attempting to HANG it on a Spider Leg). In such cases, GAME PIECES that are already in the POSSESSION of the ROBOT may be played. However, the additional GAME PIECE must be removed from the ROBOT (either by the ROBOT or by an ALLIANCE partner) before it can POSSESS a new GAME PIECE. GAME PIECES may not be intentionally placed on opposing ROBOTS for the purpose of causing a violation of this rule. Any such GAME PIECE placements will not be considered in POSSESSION of the affected ROBOT, and will be ignored.
- <G10>** SPIDER LEG loading - A maximum of two GAME PIECES may HANG from any one SPIDER LEG. While it may be physically possible to force a configuration in which additional GAME PIECES may be supported by the SPIDER LEG, only the first two will be considered HANGING when calculating scores at the end of the match. All additional GAME PIECES on a single SPIDER LEG will be ignored.

- <G11>** SCORING SPIDER LEGS - when an ALLIANCE legally HANGS a KEEPER or RINGER on a SPIDER LEG, the SPIDER LEG is then SCORED for the ALLIANCE. The SPIDER LEG stays SCORED for the ALLIANCE unless later placement of other GAME PIECES on the same SPIDER LEG cause the SCORING to be negated (e.g. by HANGING a SPOILER over a RINGER on the SPIDER LEG).
- <G12>** KEEPER scoring - A SPIDER LEG can only be SCORED with a KEEPER during the AUTONOMOUS PERIOD. At the end of the AUTONOMOUS PERIOD, any KEEPERS that are not HANGING are considered void.
- <G13>** KEEPER advantage - KEEPERS that have been SCORED can not be covered by another GAME PIECE and can not be negated by a SPOILER. Any GAME PIECE placed in a HANGING position on the same SPIDER LEG after a KEEPER (including another KEEPER) will be ignored when determining the match score. In all other aspects, KEEPERS are treated the same as RINGERS.
- <G14>** Late KEEPERS - After the AUTONOMOUS PERIOD ends, ROBOTS may not HANG any KEEPERS for the remainder of the match. Any KEEPERS that a ROBOT may POSSESS must be immediately released and dropped to the floor. If necessary, referees may validate placement of KEEPERS during the pause following the end of the AUTONOMOUS PERIOD. The referees may remove any KEEPERS that are not HANGING. If a ROBOT HANGS a KEEPER after the AUTONOMOUS PERIOD, it will result in a disqualification. If the “late KEEPER” is placed on a SPIDER LEG on which an opposing RINGER is already HANGING, the “late KEEPER” will be ignored during the calculation of the match score. If the “late KEEPER” is placed on a SPIDER LEG on which a RINGER from the same alliance is already HANGING, the two will cancel each other and both will be ignored when determining if the SPIDER LEG is SCORED. Note: as RINGERS and SPOILERS can be HANGING only after the end of the AUTONOMOUS PERIOD, any KEEPERS HANGING on a SPIDER LEG after a RINGER or SPOILER will automatically be determined to be a “late KEEPER.”
- <G15>** Double RINGERS - a RINGER can not be placed on a SPIDER LEG on which a RINGER is already HANGING. If a ROBOT HANGS a RINGER on a SPIDER LEG that already has a HANGING RINGER from the opposing ALLIANCE, the second RINGER will be ignored when calculating the match score. If a ROBOT HANGS a RINGER on a SPIDER LEG that already has a HANGING RINGER from their own ALLIANCE (for example, to prevent a SPOILER from being placed on the SPIDER LEG), the two RINGERS will cancel each other and both will be ignored when determining if the SPIDER LEG is SCORED.
- <G16>** Negating with SPOILERS - SPOILERS negate a HANGING RINGER when they HANG on a SPIDER LEG after the RINGER. The affected SPIDER LEG is considered “Null” when ROWS are identified during calculation of the ALLIANCE score.
- <G17>** Solitary SPOILERS - Single or double SPOILERS HANGING by themselves on a SPIDER LEG (i.e. not covering any RINGERS) have no affect on the SCORING of the SPIDER LEG. In either case, the affected SPIDER LEG is considered “Null” when ROWS are identified during calculation of the ALLIANCE score.
- <G18>** Removing SPOILERS - SPOILERS that are HANGING may be removed from the RACK by either ALLIANCE. Any RINGERS and SPIDER LEGS “unspoiled” by the removal of the SPOILER will then be evaluated as if they had never been “spoiled” when the final match score is determined. SPOILERS removed from the RACK are fully in play, and may be placed in any other legal position on the RACK.
- <G19>** Spoiling SPOILERS - RINGERS can HANG on a SPIDER LEG on which a single SPOILER has already been placed, thereby covering the SPOILER. In this case, the SPOILER does not negate the outer RINGER, as the SPOILER is not HANGING over it (see Rule <G16>). The SPIDER LEG is SCORED for the ALLIANCE that HANGS the RINGER.

- <G20>** De-scoring - ROBOTS may not remove RINGERS or KEEPERS once they are HANGING. If a RINGER or KEEPER is moved out of a HANGING configuration after the POSSESSING ROBOT has released it, it is still considered HANGING. If a ROBOT incidentally removes a RINGER or KEEPER from the SPIDER LEG on which it was HANGING (e.g. knocks it off while placing another GAME PIECE), a 10-point penalty will be assessed. Obviously intentional removal of a RINGER or KEEPER will result in a disqualification of the offending team.
- <G21>** SCORING for opponents - ROBOTS may not HANG a GAME PIECE of an opposing ALLIANCE. If this rule is violated a 10-point penalty will be assessed per infraction. If the ROBOT HANGS a KEEPER of from the opposing ALLIANCE, it will be ignored when determining the score. If the ROBOT HANGS a RINGER on an otherwise empty Spider Leg, it will be SCORED as if it were placed there by the opposing ALLIANCE. If the ROBOT HANGS an opposing RINGER on a Spider Leg on which their own RINGER is already HANGING, the two will cancel each other and the Spider Leg will be SCORED as "Null." If the ROBOT HANGS an opposing RINGER on a Spider Leg on which an opposing RINGER is already HANGING, the added RINGER will be ignored and the Spider Leg will continue to be SCORED for the opposing ALLIANCE.
- <G22>** GAME PIECES out of play - GAME PIECES that leave the playing field will be placed back on the field at the earliest safe opportunity. The GAME PIECES will be placed on the field at the approximate location where they exited play.
- <G23>** GAME PIECES through CHUTE – GAME PIECES may be entered onto the field through the CHUTE (see Rule <G08>). ROBOTS may not pass GAME PIECES from the Playing Field through the CHUTE into the Alliance Zone.
- <G24>** Clearing HOME ZONE – the first audio signal, sounded five seconds before the start of the END GAME, serves as a warning for ROBOTS to exit from the opposing HOME ZONE. ROBOTS attempting to exit from the HOME ZONE after the audio signal may not be blocked or impeded in this attempt.
- <G25>** END GAME play – ROBOTS may not occupy the opponents HOME ZONE during the END GAME. Any ROBOT in an opponent's HOME ZONE at the start of the END GAME will be assessed a 10-point penalty. A second 10-point penalty will be assessed if the ROBOT is still in the HOME ZONE 5 seconds after the start of the END GAME. Another 10-point penalty will be assessed if the ROBOT remains in the HOME ZONE 10 seconds after the start of the END GAME. However, a ROBOT that has been blocked or otherwise prevented from exiting the HOME ZONE (as described in Rule <G24>) will not be assessed any penalty.

7.3.3 Robot Operations

7.3.3.1 Starting Conditions

- <G26>** Starting positions - At the beginning of a match, the three alliance ROBOTS must be placed entirely inside their HOME ZONE, and not contacting any other ROBOTS. It is the responsibility of the head referee to verify that this rule is satisfied prior to the start of the match. The match will not be started until all robots are in the starting position.
- <G27>** Alignment devices - Alignment devices (templates, tape measures, etc.) that are not part of the ROBOT may not be used to assist with positioning the ROBOT. TEAMS that use external alignment devices to position their ROBOT will have their ROBOT arbitrarily repositioned by the head referee.
- <G28>** Starting size - At the beginning of a match, each ROBOT must not exceed the maximum volume specified in Section 8. The ROBOT'S maximum starting height is proportional to its maximum weight. It is the responsibility of the head referee to verify that this rule is satisfied

prior to the start of the match. The head referee may call for an inspector's recertification of the ROBOT size and weight prior to the start of any match.

<G29> ROBOT orientation - ROBOTS must start the match with their long (maximum) dimension in a vertical orientation. After the start of the match, ROBOTS may change their orientation such that the long dimension is either vertical or horizontal. Refer to Rule <R37> in Section 8 to determine how this affects the use of bumpers.

7.3.3.2 Robot Out Of Bounds

<G30> ROBOT out of bounds - Any ROBOT that touches any surface outside of the field boundary will be disabled for the remainder of the period (either AUTONOMOUS or TELEOPERATED). No penalty points will be assessed.

<G31> Grace period after autonomous - If a ROBOT should touch any surface outside of the field boundary during the AUTONOMOUS PERIOD, it will have a 10 second "grace period" to right itself and return to the playing field at the beginning of the TELEOPERATED PERIOD. If the ROBOT is unable to right itself within the grace period, it will be disabled for the remainder of the match. If at any time the referee should determine that the attempts to recover from the situation constitute unsafe operations, Rule <S01> will take precedence.

<G32> Alliance Station wall - ROBOTS may not extend/cross over the Alliance Station wall for any reason. If a violation of this rule occurs a 10-point penalty will be assessed and the ROBOT may be disabled.

7.3.3.3 Robot Actions

<G33> Field interaction - ROBOTS may push or react against any elements of the field, provided there is no damage or disruption of the field elements. ROBOTS may not grab, grasp, grapple, or attach to any field structure. Robot may not HANG GAME PIECES on the Vision System Targets, or otherwise block visual access to the Vision System Targets. If a ROBOT violates this rule, the head referee will give one warning. If the referee determines that the TEAM is disregarding the warning, their ROBOT will be disabled for the remainder of the match.

<G34> Field damage - The head referee may disable a ROBOT that has damaged the playing field, carpet, goals, GAME PIECES, etc. if the head referee feels that further damage is likely to occur. The head referee may require corrective action, such as eliminating a sharp edge, and re-inspection, before the ROBOT will be allowed to compete in subsequent matches.

<G35> Intentional ROBOT - ROBOT interaction - Strategies aimed solely at the destruction, damage, tipping over, or entanglement of ROBOTS are not in the spirit of the *FIRST* Robotics Competition and are not allowed. In all cases involving robot-to-robot contact, the head referee may assess a 10-point penalty and/or the ROBOT may be disqualified. However, Rack 'n' Roll is a highly interactive game, and some appropriate contact is allowed under the following guidelines:

- Any contact within the BUMPER ZONE is generally acceptable, with the exception of high speed, long distance ramming. If TEAMS choose not to use bumpers, and their ROBOT contacts another ROBOT such that simultaneous contact occurs both in and out of the BUMPER ZONE, then this contact is considered within the BUMPER ZONE.
- Contact outside of the BUMPER ZONE is generally not acceptable, and the offending ROBOT will be assessed a 10-point penalty, and may be disqualified from the match if the offense is particularly egregious or if it results in substantial damage to another ROBOT. Incidental contact will not be penalized. Contact outside the BUMPER ZONE

that is a result of tipping caused by contact within the BUMPER ZONE will be considered incidental contact.

- If a ROBOT extends outside of its 28 inch by 38 inch starting footprint, it is responsible for the extension's contact with other ROBOTS and must not use the extension to contact other ROBOTS outside of the BUMPER ZONE. Likewise, other ROBOTS will not be responsible for contact with the extension outside of the BUMPER ZONE. Again, incidental contact will not be penalized.
- Extension to extension contact between two ROBOTS with appendages outside the 28-inch by 38-inch starting footprint will generally not be penalized.
- Contact with a tilted ROBOT such that the contact is outside the BUMPER ZONE will generally be considered incidental contact.
- A ROBOT may attach to and/or climb onto a ROBOT on its own ALLIANCE. A ROBOT may not attach to and/or climb onto a ROBOT on an opposing ALLIANCE (doing so will be interpreted as an attempt to damage an opposing robot, and may be penalized as such).
- Use of any sloped or angled feature of the ROBOT as a wedge to overturn an opposing ROBOT is explicitly prohibited, and will be assessed as a violation of Rule <R05>.

<G36> Goal defense - ROBOTS may defend SPIDER LEGS by pushing and/or blocking other ROBOTS as they attempt to HANG GAME PIECES. If a ROBOT is in POSSESSION a GAME PIECE, a ROBOT on the opposing ALLIANCE may not grasp/attach to the GAME PIECE in order to remove it from their POSSESSION or prevent them from HANGING. A violation will result in a 10-point penalty being assessed to the offending ROBOT.

<G37> GAME PIECE entanglement - During the course of game play, it is probable that a ROBOT may insert a manipulator or other extension into the center opening of a GAME PIECE that is in the POSSESSION of an opposing ROBOT, and become momentary intertwined. This situation may occur frequently, and is NOT considered an "entanglement" situation. The ROBOTS will be permitted to extract themselves from the situation as a part of normal game play, without penalty. The one exception to this is if either ROBOT uses the intertwined state with the GAME PIECE as an opportunity to pull/tip over the opponent ROBOT by pulling on the intertwined GAME PIECE. In this case, the offending ROBOT will be disabled for the remainder of the match and the TEAM disqualified.

<G38> Entanglement – If a ROBOT entangles an opposing ROBOT, and the referee determines that the entangling action was intentional, the offending ROBOT will be disqualified. Any entangled robot may be disabled if the Head Referee deems it necessary. Robots that become entangled in the field barriers, field elements or other robots will not be freed until after the match has finished, unless the entanglement represents a safety hazard. If, due to loose cables, hoses, cordage, etc., a ROBOT unintentionally but routinely entangles another ROBOT as a result of normal game interaction, the head referee has the authority to disqualify the offending ROBOT and require that the entangling elements be repaired prior to the ROBOT'S next match.

<G39> Pinning - While on the carpeted field surface, a ROBOT cannot pin (inhibit the movement of another ROBOT while in contact with a field element or border) for more than 10 seconds. If a ROBOT has been pinned for 10 seconds, the TEAM with the pinning ROBOT will be told by a referee to release the pinned ROBOT and back away approximately 3 feet for a minimum of 3 seconds. Once the pinning ROBOT has backed off by at least 3 feet for 3 seconds, it may again attempt to pin its opponent, and if successful, the 10 second count

will start over. If a referee determines that this rule has been violated, a 10-point penalty will be assessed for each violation. Note that a ROBOT attempting to HANG a GAME PIECE on the RACK will be immune from a "pinning" violation as long as it is clear that the ROBOT is continuing to attempt to HANG the GAME PIECE.

- <G40> Detaching mechanisms - ROBOTS may not intentionally detach parts or leave multiple mechanisms on the field. Violations will result in a 10-point penalty per incident. If an intentionally detached component or mechanism significantly impedes access to the RACK or an ALLIANCE ROBOT during the END GAME, the offending ROBOT will be disqualified from the match.
- <G41> Field reset - ROBOTS must be designed to permit the release and removal of any GAME PIECES from the ROBOT without being powered up after a match. If a ROBOT violates this rule, the head referee will warn the offending TEAM and request that they modify the ROBOT. If the modification is not made, the head referee may not allow the ROBOT to compete in future matches.
- <G41-A> Violations of Rule <R12> while the ROBOT is outside of the HOME ZONE during match play will be penalized. A violation of this rule may result in the ROBOT being disabled or disqualified, based on the severity of the infraction.

7.3.4 Team Member Actions

- <G42> Number of people in the ALLIANCE ZONE - Each TEAM shall include a maximum of one HUMAN PLAYER, two DRIVERS, and one COACH. Any ALLIANCE with additional personnel in the ALLIANCE ZONE will be assessed a 10-point penalty, and the additional person must leave the ALLIANCE ZONE before the match can proceed.
- <G43> Travel within the ALLIANCE ZONE - All TEAM members may travel anywhere within the ALLIANCE ZONE.
- <G44> TEAM members stepping out of ZONE - All TEAM members must stay within their ALLIANCE ZONE during the entire match. Each incident of stepping out of the ALLIANCE ZONE will result in a 10-point penalty to the offending ALLIANCE.
- <G45> TEAM members over the PLAYER'S LINE during AUTONOMOUS PERIOD - No TEAM member may pass the PLAYER'S LINE in the ALLIANCE ZONE until the conclusion of the AUTONOMOUS PERIOD. Each violation will result in a 10-point penalty to the offending ALLIANCE. Exceptions will be made in cases involving personal or robot control safety.
- <G46> Entering GAME PIECES on the field during AUTONOMOUS PERIOD - GAME PIECES may not be entered onto the field during AUTONOMOUS PERIOD. A violation of this rule will result in a 10-point penalty to the offending ALLIANCE.
- <G47> Handling GAME PIECES - Any HUMAN PLAYER, DRIVER, or COACH may handle RINGERS or SPOILERS that are in the ALLIANCE ZONE after the end of AUTONOMOUS PERIOD. GAME PIECES cannot be handled during the AUTONOMOUS PERIOD. Violations of this rule will result in a 10-point penalty to the offending ALLIANCE.
- <G48> Entering GAME PIECES onto the field - Only the HUMAN PLAYERS may enter a RINGER or SPOILER onto the field once the TELEOPERATED PERIOD begins. This may be done by attempting to throw it to a ROBOT or onto the RACK, passing it through the CHUTE to a ROBOT, or passing it through the CHUTE for pickup by a ROBOT. If GAME PIECES are thrown, they must be thrown over the top of the Alliance Station Wall, and may not be thrown around the side of the Alliance Station Wall. Violations of this rule will result in a 10-point penalty per GAME PIECE entered onto the field.
- <G49> DRIVERS Operating ROBOTS - During a match, the ROBOTS may be remotely operated solely by the DRIVERS and/or by software running in the on-board control system. Any

operation of the ROBOT by either the COACH or HUMAN PLAYER will result in the ROBOT being disabled and the offending TEAM disqualified from the match.

<G50> Respect and professional demeanor - *FIRST* Competitions promote respect and professional demeanor. In the event that any TEAM members on the playing field are uncivil towards competition field personnel or other TEAMS, the TEAM may be disqualified from the match. This rule applies to TEAMS at all times while on the playing field (including before and after the match). TEAMS will not receive match penalties for actions off the field, however event personnel will hold them accountable for their off-field actions.

7.3.5 Referee Interactions

<G51> Any discussions regarding rules, scores, or penalties must be between the DRIVERS or HUMAN PLAYERS (pre-college team members) and the head referee.

<G52> When making a ruling, the head referee may receive input from other sources, particularly Game Design Committee members, *FIRST* personnel, and technical staff that may be present at an event. However, the head referee's decision is final (also see Rule <T04>).

7.3.6 Scoring

When playing Rack 'n' Roll, points are awarded based on the number and length of horizontal and vertical ROWS of SCORED SPIDER LEGS constructed by the ALLIANCE. ALLIANCES build up their scores by HANGING GAME PIECES on the SPIDER LEGS of the RACK.

<G53> The HANGING GAME PIECES cause the associated SPIDER LEG to be SCORED for the "Red" ALLIANCE, the "Blue" ALLIANCE, or "Null" (in the event the GAME PIECE is a properly placed SPOILER). A SPIDER LEG that is SCORED is considered either a SINGLETON or as part of one or two ROWS (if it is at the intersection of a horizontal and vertical ROW).

<G54> SCORING - Total point values of SCORED ROWS are as follows:

- SINGLETON - 2 points
- ROW of 2 SCORED SPIDER LEGS - 4 points
- ROW of 3 SCORED SPIDER LEGS - 8 points
- ROW of 4 SCORED SPIDER LEGS - 16 points
- ROW of 5 SCORED SPIDER LEGS - 32 points
- ROW of 6 SCORED SPIDER LEGS - 64 points
- ROW of 7 SCORED SPIDER LEGS - 128 points
- ROW of 8 SCORED SPIDER LEGS - 256 points

Note: There is not an additional 2 points for each GAME PIECE in a ROW.

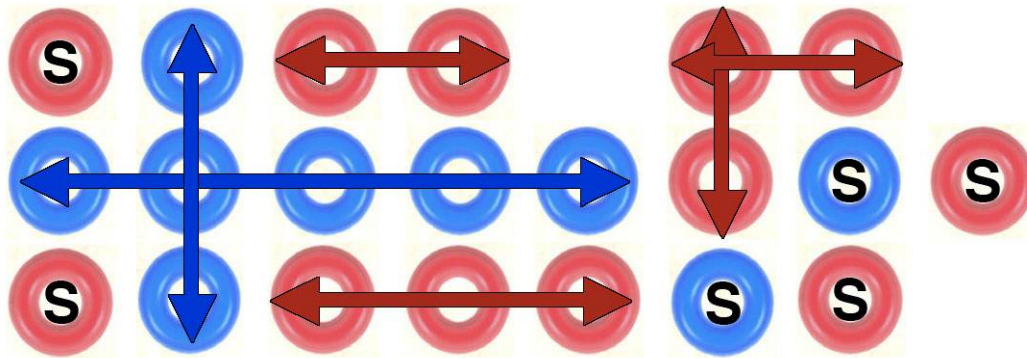







In the above illustration, the letter “S” indicates SINGLETONS and ROWS are indicated with corresponding colored arrows. In this example, the Blue ALLIANCE has created 2 SINGLETONS (for a total of 4 points), one ROW of 3 SPIDER LEGS (8 points) and one ROW of 5 SPIDER LEGS (32 points). The Red ALLIANCE has created 4 SINGLETONS (for a total of 8 points), three ROWS of 2 SPIDER LEGS (a total of 12 points) and one ROW of 3 SPIDER LEGS (8 points). The Blue ALLIANCE would receive 44 points and the Red ALLIANCE would receive 28 points.

























<G55> Deflated GAME PIECES - A GAME PIECE that has been deflated is evaluated the same as one that is inflated when determining the match score. Intentionally deflating a GAME PIECE is considered field damage (see <G34>).

<G56> ROBOTS in HOME ZONE - ROBOTS score bonus points at the end of the match if they are entirely in their HOME ZONE, not in contact with any element of the field (carpet, alliance station, goal, etc.), not supported by a GAME PIECE, and the lowest point of the ROBOT is higher than 4 inches and/or 12 inches above the carpeted field surface. The number of bonus points an ALLIANCE receives is based on the total number of ROBOTS satisfying these conditions. Each ALLIANCE ROBOT entirely in their HOME ZONE at the end of the match is eligible to receive the following bonus points:

- Each ROBOT between 0 and 3.9 inches above floor level - 0 bonus points
- Each ROBOT between 4.0 and 11.9 inches above floor level - 15 bonus points
- Each ROBOT 12.0 inches or more above floor level - 30 bonus points

<G57> The following table illustrates the possible configurations of GAME PIECES that can HANG on the SPIDER LEGS, and how each configuration is interpreted when SCORING ROWS.

OBJECTS (INNER/OUTER)	SCORED AS / RELATED RULE	OBJECTS (INNER/OUTER)	SCORED AS / RELATED RULE
	BLUE Rule <G11>		RED Rule <G11>
	BLUE Rule <G11>		RED Rule <G11>
	BLUE Rule <G13>		RED Rule <G13>

	NONE Rule <G16>		NONE Rule <G16>
	BLUE Rule <G13>		RED Rule <G13>
	BLUE Rule <G13>		RED Rule <G13>
	BLUE Rule <G13>		RED Rule <G13>
	BLUE Rule <G13>		RED Rule <G13>
	BLUE Rule <G14>		RED Rule <G14>
	BLUE Rule <G15>		RED Rule <G15>
	BLUE Rule <G19>		RED Rule <G19>
	NONE Rule <G14>		NONE Rule <G14>
	NONE Rule <G15>		NONE Rule <G15>
	NONE Rule <G17>		NONE Rule <G17>
	NONE Rule <G14>		NONE Rule <G14>

Note: this chart is based on the premise that ROBOTS are HANGING GAME PIECES of their own color on the Rack. Exceptions to the chart occur when ROBOTS HANG opponent GAME PIECES. These exceptions are explained in Rules <G15> and <G21>.

Section
8



THE ROBOT

TABLE OF CONTENTS

8 THE ROBOT	2
8.1 OVERVIEW.....	2
8.1.1 What is a FIRST Robot?.....	2
8.1.2 Getting Started.....	2
8.1.3 Related Documents & Resources.....	3
8.1.4 Conventions.....	3
8.2 DEFINITIONS	3
8.3 ROBOT RULES	6
8.3.1 General Design & Safety Rules	7
8.3.2 Robot Physical Rules.....	8
8.3.3 Fabrication Schedule	10
8.3.4 Robot Material Utilization Rules.....	12
8.3.5 Electrical System Rules	21
8.3.6 Custom Circuit Rules	22
8.3.7 Control System Rules	23
8.3.8 Operator Interface Rules.....	24
8.3.9 Wiring Rules	25
8.3.10 Pneumatic System Rules.....	26
8.3.11 Non-Functional Decoration Rules	28
8.3.12 Robot Inspection Rules.....	28

8 THE ROBOT

8.1 OVERVIEW

This section of the 2007 *FIRST* Robotics Competition Manual provides:

- NEW Rules applicable to the design and construction of the 2007 Robot.
- Descriptions of NEW mechanical and electrical systems that are based on parts provided in the 2007 Kit Of Parts (KOP).

Compliance with all Rules is mandatory.

Robots will be inspected at each *FIRST* event to verify rules compliance before being allowed to compete.

8.1.1 What is a FIRST Robot?

A *FIRST* robot is a remotely operated vehicle designed and built by a *FIRST* Robotic Competition team to perform specific tasks when competing in the 2007 competition "Rack 'n' Roll".

8.1.2 Getting Started

Please be sure to thoroughly read and understand Sections 4, 6, 7, 8, and 9 of this manual before designing your robot. In particular, pay attention to *Section 8.3.1. General Design & Safety Rules* and *Section 8.3 Robot Rules* before proceeding. The following are just a few important points offered to help teams in getting started:

- 1) Evaluate the Game's physical challenges and identify those that the robot will have to overcome.
 - Will it have to climb, pick and place items, push / pull objects or robots, possess a low profile, extend its height, lift items, hang, etc.?
 - What are the game's implications regarding the robot's center of gravity?
 - Are unique field surface characteristics important when determining robot driving mechanism design?
 - Are there any particular offensive / defensive capabilities important to the robot?
- 2) Inspect all items provided in the Kit Of Parts (see Section 10) and review their basic features. Note that suppliers' data sheets are referenced in the Kit Of Parts tables for many of the components in the Kit.
- 3) We recommend that you carefully read the documents listed in Section 8.1.3 Related Documents & Resources.
- 4) Look over the specifications and technical notes provided for the various Kit Of Parts components.
- 5) Note all Safety Rules relating to the robot's design. They include:
 - The locations and ratings of circuit breakers where indicated in the wiring diagrams
 - Wire size
 - Stored energy guidelines
 - Attention to sharp corners and edges

- Shields for moving parts and pinch points

8.1.3 Related Documents & Resources

In addition to this chapter, other sections in this manual and other documents should be reviewed before proceeding with the robot design process. Note that all referenced documents are available on-line at http://www.usfirst.org/robotics/doc_updt.htm

- Section 6: The Arena, Section 7: The Game and Section 9: The Tournament
- Section 4.5.1.1: Crate Shipping Deadlines as listed in Section 4: Robot Transportation
- *FIRST* Guidelines, Tips, and Good Practices
- Innovation First, Inc. instruction manuals for the *Robot Controller*, *Spike relay modules*, and *Victor 884 speed controllers* as provided by their manufacturer
- *FIRST* 2007 Chassis Kit Manual – Information to assemble chassis kit available at: <http://www.ifirobotics.com/kitbot.shtml>.
- *FIRST* 2007 Software Quick Start Guide – A guide to software tools available for robot and vision system programming.
- 2007 CMUCam2 Engineering Workbook – A guide to vision system programming using EasyC software applications.
- *FIRST* 2007 Pneumatics Manual - Valuable information about the pneumatic components and ordering processes are included.
- *FIRST* 2007 Sensors Manual – Helpful information regarding the application, assembly, and programming of the sensors included in the 2007 Kit Of Parts.
- 2007 Robot Power Distribution Diagram

8.1.4 Conventions

Specific methods are used throughout this section to highlight warnings, cautions, key words or phrases to alert the reader to important information designed to help teams in constructing a robot complying with the rules in a safe and workmanlike manner.

Warnings, cautions, and notes appear in bordered boxes. Key words that have a particular meaning within the context of the 2007 *FIRST* Robotics Competition are defined in Sections 6, 7.2 and 8.2, and indicated in ALL CAPITAL letters throughout this text. References to other sections of the manual appear in ***bold italics***. References to specific rules within the manual are indicated with a bracketed reference to the rule (e.g. “Rule <S01>”). Operating keys, controls, buttons appear in bold capital letters (i.e. **OFF/ON** switch or **RESET** button).

8.2 DEFINITIONS

COMPONENT – A **ROBOT** part in its most basic configuration, which can not be disassembled without damaging or destroying the part, or altering its fundamental function.

- Example 1: raw aluminum stock, pieces of steel, wood, etc., cut to the final dimensions in which they will be used on the **ROBOT**, would all be considered components. Bolting pieces of extruded aluminum together as a **ROBOT** frame would constitute a **MECHANISM**, and the collection of pieces would not be considered a **COMPONENT**.
- Example 2: a COTS (See immediately below) circuit board is used to interface to a sensor on the **ROBOT**, and it includes the circuit board and several electrical elements soldered to the board. The board is considered a **COMPONENT**, as this is the basic form in which

it was purchased from the vendor, and removing any of the electrical elements would destroy the functionality of the board.

COTS – A “Commercial, Off-The-Shelf” COMPONENT or MECHANISM, in it’s unaltered, unmodified state. A COTS item must be a standard (i.e. not custom order) part commonly available from the VENDOR, available from a non-team source, and available to all teams for purchase.

- Example 1: a team orders two robot grippers from RoboHands Corp. and receives both items. They put one in their store room and plan to use it later. Into the other, they drill “lightening holes” to reduce weight. The first gripper is still classified as a COTS item, but the second gripper is now a “custom part” as it has been modified.
- Example 2: a team obtains openly available blueprints of a drive component commonly available from Wheels-R-Us Inc. and has local machine shop “We-Make-It, Inc.” manufacture a copy of the part for them. The produced part is NOT a COTS item, because it is not commonly carried as part of the standard stock of We-Make-It, Inc.

FABRICATED ITEM – Any COMPONENT or MECHANISM that has been altered, built, cast, constructed, concocted, created, cut, heat treated, machined, manufactured, modified, painted, produced, surface coated, or conjured into the final form in which it will be used on the ROBOT.

- Example 1: A piece of extruded aluminum has been ordered by the team, and arrives in a 20-foot length. To make it fit in their storage room, the team cuts it into two ten-foot lengths. These would not be considered FABRICATED ITEMS, as they have not been cut to the final length in which they will be used on the ROBOT.
- Example 2: A team designs an arm mechanism that uses gears with a 1/2-inch face width. They order a 12-inch length of gear stock and cut it into precise 1/2 inch slices. They do not bore out the mounting bores in the center of the gears. The slices are now considered FABRICATED ITEMS, as they have been cut to final size, even though all the machining operations (the center bore) may not yet be completed.

FIX-IT-WINDOWS – Two 5-hour work periods following the deadline for shipping the ROBOT, or following the close of a regional competition, in which ALL teams may manufacture parts in preparation for future competitions. During the FIX-IT WINDOWS, software for either the ROBOT or Operator Interface may be developed without restriction. The FIX-IT WINDOWS are limited to single continuous time periods with a maximum duration of 5 hours each. Part or all of the team may participate in the work conducted during this period. The FIX-IT WINDOWS can not be subdivided into multiple work sessions of lesser duration.

FLAG – A colored (red or blue) bicycle flag used to display ALLIANCE assignments during a match. The flag itself is made of a triangular piece of colored plastic or fabric, measuring approximately 9 inches tall by 11 inches long. The flag is mounted at the end of a 1/4 inch diameter fiberglass flagpole, approximately 36 inches long.

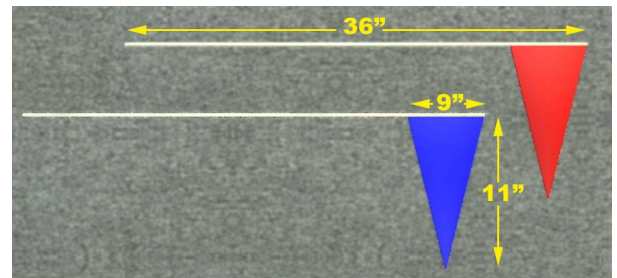

MECHANISM – A COTS or custom assembly of COMPONENTS that provide specific functionality on the ROBOT. A MECHANISM can be disassembled (and then reassembled) into individual COMPONENTS without damage to the parts.

OPERATOR CONSOLE – the Innovation First-provided Operator Interface unit and any associated equipment, control interfaces, display systems, structure, decorations, etc. used by the DRIVERS to operate the ROBOT.

PLAYING CONFIGURATION - The physical configuration and orientation of the ROBOT while playing the game (i.e. after the match has started, and the ROBOT has deployed mechanisms, moved away from the starting location, and/or interacted with the field, GAME PIECES, or other ROBOTS). This configuration is dynamic, and may change multiple times during the course of a single match.

REPLACEMENT PARTS – A COMPONENT or MECHANISM constructed as a functional duplicate of an existing part of the ROBOT, for the purpose of replacing a broken or defective part. REPLACEMENT PARTS may be either COTS items or FABRICATED ITEMS. They must be functionally identical to the original part but can be modified to provide more robust performance of the function.

- Example 1: A lever arm made of lexan on your ROBOT breaks. You manufacture a REPLACEMENT PART made of aluminum plate, using the design drawings of the original. As the new part provides the same function as the broken part, the new part is a valid REPLACEMENT PART.
- Example 2: A sensor on the ROBOT is connected to the control system with 24-gauge single-strand wire, and runs across a hinged joint. The flexing of the wire causes it to break, and you want to replace it with 18-gauge multi-strand wire. If the new wire follows the same path as the original and connects only the same devices, then it is a valid REPLACEMENT PART (i.e. it has added robustness without changing function). But if the wire is then used to connect an additional sensor to the same circuit, it is providing a functionally different capability, and is no longer a “replacement.”

SPARE PARTS – A COMPONENT or MECHANISM constructed as an identical duplicate of an existing part of the ROBOT, for the purpose of replacing a broken or defective part. SPARE PARTS may be either COTS items or FABRICATED ITEMS, but they must be physically and functionally identical to the original part.

STARTING CONFIGURATION – The physical configuration and orientation of the ROBOT when the match is started. This is the state of the ROBOT immediately before being enabled by the Arena Controller, before the ROBOT takes any actions, deploys any mechanisms, or moves away from the starting location. This configuration is static, and does not change during a single match (although it may change from match to match).

STANDARD BUMPERS – Bumper assemblies designed to attach to the exterior of the ROBOT within the BUMPER ZONE, and constructed as specified in Rule <R37>. STANDARD BUMPERS may weigh up to 15 pounds, and are excluded from the weight and volume calculations specified in Rule <R07>.

UPGRADE PARTS - A COMPONENT or MECHANISM intended to provide additional functionality not currently available on the ROBOT. UPGRADE PARTS may be COTS items or custom FABRICATED ITEMS, and may either add to or replace existing functionality.

- Example 1: A ROBOT is designed with a four-wheel drive system. The system works well on flat floors, but high-centers when trying to drive up steps. The team adds two more wheels on the centerline of the ROBOT to prevent this problem, and the wheels are identical to those already on the ROBOT. The new wheels would be considered UPGRADE PARTS even though they are the same as the ones already in place, as they alter the functionality of the ROBOT and provide new capability.

VENDOR – A legitimate business source for COTS items that, as a minimum, satisfies the following criteria:

- The VENDOR must have a Federal Tax Identification number. The Federal Tax Identification number establishes the VENDOR as a legal business entity with the IRS, and validates their status as a legitimate business. In cases where the VENDOR is outside of

the United States, they must possess an equivalent form of registration or license with the government of their home nation that establishes and validates their status as a legitimate business licensed to operate within that country.

- The VENDOR must be normally able to ship any general (i.e., non-*FIRST* unique) product within five business days of receiving a valid purchase request. It is recognized that certain unusual circumstances (such as 1,000 *FIRST* teams all ordering the same part at once from the same VENDOR) may cause atypical delays in shipping due to backorders for even the largest VENDORS. Such delays due to higher-than-normal order rates are excused.

Note that the intent here is to protect the teams against long delays in availability of parts that will impact their ability to complete their ROBOT. The *FIRST* Robotics Competition build season is only six weeks long, so the VENDOR must be able to get their product, particularly *FIRST* unique items, to a team in a timely manner.

- The business should maintain sufficient stock or production capability to fill teams orders within a reasonable period during the build season (less than 1 week). Note that this criterion may not apply to custom-built items from a source that is both a VENDOR and a fabricator. For example, a VENDOR may sell flexible belting that the team wishes to procure to use as treads on their drive system. The VENDOR cuts the belting to a custom length from standard shelf stock that is typically available, welds it into a loop to make a tread, and ships it to a team. The fabrication of the tread takes the VENDOR two weeks. This would be considered a FABRICATED ITEM, and the two weeks ship time is acceptable. Alternately, the team may decide to fabricate the treads themselves. To satisfy this criterion, the VENDOR would just have to ship a length of belting from shelf stock (i.e. a COTS item) to the team within five business days and leave the welding of the cuts to the team.
- The VENDOR makes their products available to all *FIRST* Robotics Competition teams.
- VENDORS must not limit supply or make a product available to just a limited number of *FIRST* Robotics Competition teams.
- Ideally, chosen VENDORS should have national distributors.
 - Example: distributors include Home Depot, Lowes, MSC, Radio Shack, and McMaster-Carr. *FIRST* competition events are not usually near home. When parts fail, local access to replacements is often critical.

FIRST desires to permit teams to have the broadest choice of legitimate sources possible, and to obtain COTS items from the sources that provide them with the best prices and level of service available. The intent of this definition is to be as inclusive as possible to permit access to all legitimate sources, while preventing ad hoc organizations from providing special-purpose products to a limited subset of teams in an attempt to circumvent the cost accounting rules.

8.3 ROBOT RULES

These rules establish the global robot construction and performance constraints dictated by the characteristics of the provided Kit Of Parts along with the size and weight design limits specified in this section. **Compliance with the rules is mandatory! Any ROBOT construction not in compliance with the rules (determined at inspection) must be rectified before a ROBOT will be allowed to compete.**

When reading these Rules, please use technical common sense (engineering thinking) rather than “lawyering” the interpretation and splitting hairs over the precise wording in an attempt to find loopholes. Try to understand the reasoning behind a rule.

8.3.1 General Design & Safety Rules

- <R01>** Each registered FIRST Robotics Competition team can enter ONE (1) ROBOT into the 2007 FIRST Robotics Competition. That ROBOT must be assembled using materials from the 2007 FIRST Kit Of Parts, and other allowed materials as specified in the Rules, and must fully comply with all Rules.
- <R02>** Energy used by *FIRST* Robotics Competition ROBOTS, (i.e., stored at the start of a match), can only come from the following sources:
- Electrical energy derived from the onboard 12V and 7.2V batteries
 - Compressed air stored in the pneumatic system, and stored at a maximum pressure of 120 PSI in no more than four Clippard Instruments tanks. This compressed air must be supplied by the compressor included in the Kit Of Parts, and can not come from any other source.
 - A change in the altitude of the ROBOT center of gravity.
 - Storage achieved by deformation of ROBOT parts. Teams must be very careful when incorporating springs or other items to store energy on their ROBOT by means of part or material deformation. A ROBOT may be rejected at inspection if, in the judgment of the inspector, such items are unsafe.
- <R03>** Protrusions from the ROBOT must not pose hazards to team members or event staff. If, in the judgment of the inspectors or referees, a device on the ROBOT poses a hazard (particularly puncture or impalement hazards), the team will be required to remedy the situation before the ROBOT will be allowed to play. If the ROBOT includes protrusions that form the “leading edge” of the ROBOT as it drives, and are less than one square inch in surface area, it will invite detailed inspection. For example, forklifts, lifting arms, grapples, etc. may be carefully inspected for these hazards.
- <R04>** Exterior or exposed surfaces on the ROBOT must not present undue hazards to the team members, event staff or GAME PIECES. Reasonable efforts must be taken to remove, mitigate, or shield any sharp edges, pinch points, entanglement hazards, projectiles, extreme visual/audio emitters, etc. from the exterior of the ROBOT. Any of these potential hazards will be carefully inspected.
- <R05>** “Wedge” ROBOTS are not allowed. ROBOTS must be designed so that interaction with opposing ROBOTS results in pushing rather than tipping or lifting. Neither offensive nor defensive wedges are allowed. All parts of a ROBOT between 0 and 8.5 inches from the ground (the top of the BUMPER ZONE) that are used to push against or interact with an opposing ROBOT must be within 10 degrees of vertical. Devices deployed outside the ROBOT footprint should be designed to avoid wedging. If a mechanism or an appendage (e.g. a harvester for retrieving GAME PIECES) becomes a wedge that interferes with other ROBOTS, penalties, disabling, or disqualification can occur depending on the severity of the infraction.
- <R06>** Ramps, platforms as other mechanisms specifically designed to elevate ROBOTS during the END GAME are exempt from Rule <R05> when they are deployed in the HOME ZONE. Such devices deployed outside the HOME ZONE are not covered by this exemption.

8.3.2 Robot Physical Rules

8.2.3.1 Robot Dimensions

<R07> Prior to the beginning of the match, the ROBOT must be placed in a STARTING CONFIGURATION that fits within one of the three permitted classes of dimensions listed below:

	<u>Maximum Width</u>	<u>Maximum Depth</u>	<u>Maximum Height</u>	<u>Maximum Weight</u>
Class 1:	28 inches (71.12cm)	38 inches (96.52cm)	48 inches (121.92cm)	120 pounds (54.43Kg)
Class 2:	28 inches (71.12cm)	38 inches (96.52cm)	60 inches (152.40cm)	110 pounds (49.89Kg)
Class 3:	28 inches (71.12cm)	38 inches (96.52cm)	72 inches (182.88cm)	100 pounds (45.36Kg)

Any restraints (elastic bands, springs, etc.) that are used to restrain the ROBOT in its STARTING CONFIGURATION must remain attached to the ROBOT for the duration of the match.

<R08> The ROBOT will be inspected for compliance with the maximum permissible dimensions while in its STARTING CONFIGURATION. The ROBOT must fit within a *FIRST* Sizing Device that has inside surface dimensions as specified in Rule <R07>. Other than resting on the floor of the Sizing Device, no part of the ROBOT can break the plane of the sides or top of the Sizing Device during size inspection. The ROBOT must be self-supporting while in the Sizing Device.

<R09> At the time of inspection, the team must declare in which weight/height class (as specified in Rule <R07>) the ROBOT will be configured for the competition. Once inspected for the declared weight/height class, the ROBOT must remain within the weight/height restrictions of that class for the duration of the competition event. Modifications or changes to the configuration of the ROBOT after the start of the competition that change the weight/height class of the ROBOT will not be permitted.

<R10> At weigh-in, the basic ROBOT structure and all elements of all additional mechanisms that might be used in different configurations of the ROBOT must be weighed together. Included in the weight limit are the robot control system, back-up 7.2V battery, decorations, and all other attached parts.

- Example: A team has decided to design their “Class 1” ROBOT such that, before any given match, they may change the configuration of the ROBOT based on perceived strengths or weaknesses of an opposing ROBOT. The team accomplished this by constructing its ROBOT as a basic drive train platform plus two versions of a GAME PIECE manipulator, each manipulator being a quick attach / detach device such that either one or the other (but not both) may be part of the ROBOT at the beginning of a match. Their ROBOT platform weighs 107 lb, version A of the manipulator weighs 6 lb, and version B weighs 8 lb. Although only one version will be on the ROBOT during a match, both manipulators (and all components of the manipulators that would be used during the match) must be on the scale along with the ROBOT platform during weigh in. This would result in a **rejection** of the ROBOT because its total weight comes to 121 lb.

<R11> For the purposes of determining compliance with the weight and volume limitations specified in Rule <R07>, these items are NOT considered part of the ROBOT and are NOT included in the weight and volume assessment of the ROBOT:

- The 12V battery and its associated half of the Anderson cable quick connect/disconnect pair (including no more than 12 inches of cable per leg, the associated cable lugs, connecting bolts, and insulating electrical tape) on board the ROBOT.
- Any STANDARD BUMPER assemblies included on the ROBOT that are in compliance with Rule <R37>, up to a maximum of 15 pounds.
- The FLAG is not considered part of the ROBOT. However, the flag holder specified in Rule <R15> IS considered part of the ROBOT, and is included in the weight and volume determination
- The OPERATOR CONSOLE.

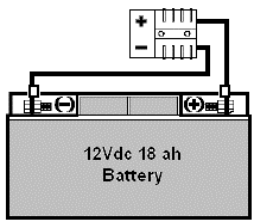
NOTE	
- Weight limit excludes the 12 volt battery and Anderson cable half.	
- Weight and volume limits exclude any STANDARD BUMPERS constructed consistent with Rule <R37>.	
- Weight and height limits exclude the FLAG	

However, for all other purposes the items listed above are considered part of the ROBOT and must comply with all other applicable rules and requirements. In particular, these items are subject to the shipping deadlines specified in Section 4 and must ship in the crate with the rest of the ROBOT.

<R12> Once the match has started, the ROBOT may assume a PLAYING CONFIGURATION that exceeds the size dimensions specified in Rule <R07>. While outside of its HOME ZONE, a ROBOT may expand up to a maximum width of 72 inches and depth of 72 inches. While entirely inside of its own HOME ZONE, there is no limit to the maximum width or depth of the ROBOT, as long as it remains entirely within the HOME ZONE. There are no height limits for a ROBOT in its PLAYING CONFIGURATION at any time after the start of the match (other than those naturally created by the ceiling height of the competition venue).

8.3.2.3 Robot Visibility

<R13> ROBOTS must display their school name, and primary sponsor name and/or logo whenever the ROBOT is on the field (including practice sessions). The support provided by the corporate sponsors and mentors on your team is important, and is to be acknowledged with the appropriate display of their names/logos on the exterior of the ROBOT.

<R14> The judges, referees, and announcers must be able to easily identify ROBOTS by Team Number. Teams must display their Team Number in four locations at approximately 90-degree intervals around the perimeter of the ROBOT. *The numerals must be at least 4 inches high, at least in 3/4- inch stroke width and in a contrasting color from its background. Team Numbers must be clearly visible from a distance of not less than 100 feet.*

<R15> ROBOTS must use one of the two FLAGS provided at the event queuing location to display their ALLIANCE color (red or blue). The FLAG must be held in a flag holder mounted on the ROBOT. The only acceptable flag holder is a 12 inch long piece of 1/2" ID Schedule 40 PVC tube. The tube must be a single, contiguous piece, must be capped with a commercial PVC pipe cap cemented at one end. The tube can not have any "lightening holes" or other modifications other than mounting holes (paint or other decorative surface finishes are permitted). The flag holder must be permanently mounted to the ROBOT such that when the ROBOT is in any PLAYING CONFIGURATION and the FLAG is in the flag holder, the FLAG is approximately vertical and the top of the FLAG is a minimum of 18 inches higher than any point on the central mass or structure of the ROBOT (note: ROBOT arms, appendages, and extensions may temporarily intrude into the space above the top of the ROBOT and exceed this height of the FLAG – this a normal part of game play, and will not be considered a violation of this rule). The intent of this rule is to insure that the FLAG must be easily seen from any side during the entire match play.

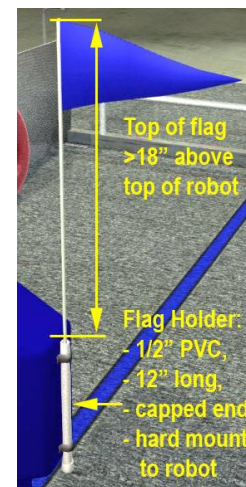

<R16> ROBOTS must use the panel signal device provided in the Kit Of Parts. Field personnel will use the panel signal device during the matches for diagnostic purposes. It must be mounted on the ROBOT such that it is easily visible while standing three feet in front of the ROBOT in its' STARTING CONFIGURATION. Instructions for connecting the panel signal device are provided on the *FIRST* website at www.usfirst.org/frc/2007/manual. The Robot Controller directly powers and controls the panel signal device. The user has no control over the panel signal device and no programming is required.

8.3.3 Fabrication Schedule

One of the fundamental values of *FIRST* is the concept of "gracious professionalism." *FIRST* recognizes that it is the responsibility of each team to abide by the fabrication schedule rules defined below. As compliance with these rules takes place outside of the competition venues, *FIRST* is not able to directly monitor compliance. We are relying upon the honor, integrity, and professional behavior of each team to recognize and abide by the fabrication schedule rules. Teams must design and construct their ROBOT within the schedule constraints defined below.

Note that the schedule rules apply to both hardware and software development. Hardware and software design processes are thought-intensive activities, and team members are likely to continue to consider and analyze their designs long after the ROBOT is shipped. Teams can not be prevented from thinking about their hardware and software designs, and it is not our intention to do so. However, the timeline permitted for the development of the actual competition version of the ROBOT is severely, and intentionally, restricted. Pondering software issues to be resolved, researching general case solutions, discussing solutions with teammates, collecting raw materials, sketching mechanisms, preparing tools, and outlining high-level descriptions of software algorithms are all reasonable activities outside of the scheduled build periods. But completing detailed dimensioned drawings of parts, and any actual fabrication of any hardware items intended to go on the actual competition ROBOT is prohibited outside of the approved fabrication periods. On the software side, developing detailed pseudo-code, writing actual lines of code, verification of syntax, final debugging, etc would all be considered development of the final software implementation, and must be completed during the approved fabrication periods.

- <R17>** Prior to the Kick-off: Before the formal start of the Robot Build Season, teams are encouraged to think as much as they please about their ROBOTS. They may develop prototypes, create proof-of-concept models, and conduct design exercises. Teams may gather all the raw stock materials and COTS COMPONENTS they want. But absolutely no fabrication or assembly of any elements intended for the final ROBOT is permitted prior to the Kick-off presentation.
- <R18>** During the Build Season: During the period between the Kick-off and ROBOT shipment deadline, teams are to design and fabricate all the COMPONENTS and MECHANISMS required to complete their ROBOT. They are encouraged to use all the materials, sources and resources available to them that are in compliance with the rules of the 2007 *FIRST* Robotics Competition. When the ROBOT shipment deadline arrives, all work on the ROBOT must cease and the ROBOT must be placed in a “hands-off” condition. The entire ROBOT (including all FABRICATED ITEMS intended for use during the competition in alternative configurations of the ROBOT) and OPERATOR CONSOLE must be crated and out of team hands by the shipment deadline specified in Section 4.5.1.1.
- <R19>** During the “FIX-IT WINDOWS” following the shipment of the ROBOT: During this period, all teams may utilize one or two 5-hour FIX-IT-WINDOWS to manufacture SPARE and REPLACEMENT PARTS and develop software for their ROBOT at their home facility. Fabrication of UPGRADE PARTS is not permitted during this period. The timing of these “FIX-IT WINDOWS” is at the discretion of the team, but all work must be completed by 5:00pm on the Friday following the ROBOT shipment deadline. Teams may manufacture all the SPARE and REPLACEMENT parts they want, but the amount of parts they can bring to a competition event is limited (as specified in Rule <R31>).

The intent of the FIX-IT WINDOWS is to permit teams to prepare parts that have, or are likely to, become damaged during the course of a competition event, so they may continue to participate. Teams do not have direct access to their ROBOT during these periods, and must rely on information they generated and documented during the design and build process to determine the fit and function of any parts developed during FIX-IT WINDOWS. This is true for both hardware and software.

- <R20>** Prior to the competitions: After the close of the “FIX-IT WINDOWS” and prior to the competition, the team must put down their tools, cease fabrication of ROBOT parts, and cease all development of ROBOT software. Take this opportunity to rest, recover from the build season, and relax. Teams may scout other teams, gather and exchange information, develop game-playing strategies, collect raw materials, prepare tool kits, plan how to make repairs, etc. in preparation for the upcoming competitions. But no construction or fabrication of any hardware, or development of any software, is allowed.
- <R21>** At the competitions: Teams are allowed to repair, modify or upgrade their competition ROBOT while participating in a competition event. To support this, teams may bring SPARE, REPLACEMENT and UPGRADE PARTS and COTS items to the competitions (within the limits specified in Rules <R30> and <R31>). Work can only be done on-site in the Pits or at any facility made available to all teams at the event (e.g., in a team’s repair trailer or a local team’s shop offered to all teams to use). Fabrication may be done when the Pit area is open for normal operations during the period starting with the opening of the Pit area on Thursday and ending at 4:00PM on Saturday. All work must be completed when the Pit area closes each evening. Parts cannot be removed from the competition site and retained overnight after the Pit area closes.

<R22> During the “FIX-IT WINDOW” following each Regional Competition weekend: During this period, all teams (not just those teams attending a Regional Competition) may utilize one or two 5-hour FIX-IT-WINDOWS to manufacture SPARE, REPLACEMENT and UPGRADE PARTS and develop software for their ROBOT at their home facility (not at the competition site). The timing of these “FIX-IT WINDOWS” is at the discretion of the team, but all work must be completed between the **opening of the Competition (at 8:30 am on the Thursday of the Competition weekend) and 8:30 am on the Thursday** following the Competition weekend. At the conclusion of a regional competition event, teams may take a limited amount of broken or malfunctioning COMPONENTS or MECHANISMS back to their home facility to make SPARE or REPLACEMENT PARTS. The purpose of this rule is to allow teams to make critical repairs to existing parts to enable them to compete in following events. The intent of this rule is not to have teams take their entire ROBOT back home and make large-scale revisions or upgrades to the ROBOT. Teams may manufacture and/or repair all the parts they want, but the amount of parts they can bring to the competition event is limited (as specified in Rule <R31>).

8.3.4 Robot Material Utilization Rules

- <R23> Robots entered into the 2007 *FIRST* Robotics Competition must be fabricated and/or assembled from COMPONENTS, MECHANISMS and COTS items that are constructed from:
- Items provided in the *FIRST* supplied Kit Of Parts (or their exact replacement part)
 - Allowed Additional Parts and Materials as defined in this section in quantities consistent with the Cost Accounting Rules (found in Section 8.3.4.3).
- <R24> FABRICATED ITEMS from ROBOTS entered in previous *FIRST* competitions can not be used.
- <R25> Teams participating in the 2007 *FIRST* Robotics Competition that are located outside North America may not be able to acquire the exact part (as identified by specific part numbers) or materials of the specified dimensions as defined in these rules. In such situations, international teams must submit a request for approval of nearest-equivalent parts (e.g. nearest metric equivalent, etc.) to *FIRST* Headquarters. *FIRST* will determine suitability of the part. If approved, a confirming e-mail will be sent to the team. The team must bring a copy of the e-mail to any competition event to verify that the use of an alternate part has been approved.
- <R26> Individual COMPONENTS or MECHANISMS retrieved from previous ROBOTS and used on 2007 ROBOTS must have their un-depreciated cost included in the 2007 robot cost accounting, and applied to the overall cost limits.
- <R27> Motors, pumps, and, Robot Controllers from previous robots can not be used in addition to those provided in the 2007 Kit Of Parts. They may be used as direct one-to-one SPARE PARTS for those provided if the provided part fails or is damaged. They can only be used if they are identical to the part being replaced. Note that the Fisher-Price motor found in the 2007 Kit Of Parts (Part number 00968-9012) is different from the Fisher-Price motors used in most previous *FIRST* competitions. Only the Fisher-Price 00968-9012 motor may be used as a SPARE PART for the Fisher-Price motors provided in the 2007 Kit Of Parts.

- <R28> COTS ITEMS that are generally available may be used on the ROBOT. COTS ITEMS from ROBOTS entered in previous FIRST competitions or COTS ITEMS that are no longer commercially available may be used under the following conditions:
- ° The item must be unmodified, and still in its original condition as delivered from the VENDOR
 - ° The item must not be a part custom made for the *FIRST* competition and provided in a previous FRC Kit Of Parts (e.g. 2006 FRC transmissions, custom-made motor couplers, custom sensor strips, IFI CMUcam II modules, etc. are not permitted)
 - ° The item must satisfy ALL of the rules associated with materials/parts use for the 2007 *FIRST* Robotics Competition
- <R29> Only Innovation First Incorporated “Victor 884” speed controllers and “Spike” relay modules are permitted. Other makes and models of relay modules and speed controllers (including the Victor 883 and 885 speed controllers) cannot be used.
- <R30> Teams may acquire and bring an unlimited amount of COTS items to the competitions to be used to repair and/or upgrade their ROBOT at the competition site.
- <R31> Teams may bring a maximum of 25 pounds of custom FABRICATED ITEMS (SPARE PARTS, REPLACEMENT PARTS, and/or UPGRADE PARTS) to each competition event to be used to repair and/or upgrade their ROBOT at the competition site. All other FABRICATED ITEMS to be used on the ROBOT during the competition must arrive at the competition venue packed in the shipping crate with the ROBOT.
- <R32> MECHANISMS or COMPONENTS on the ROBOT must not pose obvious risk of entanglement. If, in the judgment of the inspectors, a device on the ROBOT poses an entanglement risk then the team will be required to remedy the situation before the ROBOT will be allowed to play. If the structure of a COMPONENT permits easy penetration by an object less than four square inches in cross section, it will invite detailed inspection. Willful entanglement actions are addressed in Rules <G37> and <G38> in **Section 7.3.4 – Robot Operations** of “The Game” section.
- Note: nets, loose rope or wire, voluminous sheets of fabric, etc. may be carefully inspected for these hazards. A 1/8” x 1/8” tight-mesh net (or very loose mesh fabric, depending on your point of view) may be a reasonable material that would not automatically pose an entanglement hazard. However, any flexible material has the potential to become an entanglement hazard if it is not firmly attached to an appropriate structure or left in a loose, voluminous configuration. Therefore, you must use your best judgment to determine if your particular use of the material will pose an entanglement hazard. However, actual performance on the playing field will determine if the potential for entanglement is significant or not.
- <R33> No devices or decorations are permitted on the ROBOT that are intended to jam or interfere with the operation of the vision system (i.e. changing ROBOT color to confuse opponent’s vision system).

<R34> ROBOT wheels, tracks, and other parts intended to provide traction on the playing field may be purchased or fabricated (“traction devices” include all parts of the ROBOT that are designed to transmit any propulsive and/or braking forces between the ROBOT and the playing field). In no case will traction devices that damage the carpet or other playing surfaces be permitted. Traction devices can not have surface features such as metal, sandpaper, hard plastic studs, cleats, or other attachments. Anchors (i.e. devices that are deployed/used to keep one’s ROBOT in one place and prevent it from being moved by another ROBOT) can not use metal in contact with the carpet or other playing surfaces to “stay put.” Gaining traction by using adhesives or Velcro-like fastener material is not allowed.

<R35> Adhesive backed tapes are NOT allowed except as follows:

- Velcro tape, any hook and loop tape or double-sided sticky foam may be used for attaching components to the ROBOT.
- Reflective tape may be used with optical sensors in small amounts.
- Adhesive backed tape and labels may be used for labeling purposes on wires, cables, pneumatic lines, etc.
- Electrical tape may be used as an electrical insulator.

<R36> Lubricants may be used only to reduce friction within the ROBOT. Lubricants shall not be allowed to contaminate the playing field or other ROBOTS.

<R37> Teams are strongly encouraged to use bumpers on their ROBOTS. Bumpers can reduce damage to ROBOTS when they contact another ROBOT or field elements. Teams may choose to use STANDARD BUMPERS or custom bumper designs. STANDARD BUMPERS have several advantages, such as being excluded from the calculation of the ROBOT weight and volume limitations specified in Rule <R07>. TEAMS that choose to use STANDARD BUMPERS, will have both a more robust ROBOT and the traction advantage of a heavier ROBOT. Alternately, TEAMS may develop custom bumper designs for use on their ROBOTS. However, custom bumper designs are NOT eligible for the weight/volume exclusion offered for STANDARD BUMPERS. All custom bumper designs are considered part of the ROBOT, and must satisfy the constraints listed in Rule <R07> (as well as all other rules). STANDARD BUMPERS must be designed as described below. Any bumper design inconsistent with these design elements will be considered a custom bumper.

- STANDARD BUMPERS must be designed as shown in figures 8-1 and 8-2. This is the only acceptable design for STANDARD BUMPERS.
- STANDARD BUMPERS must be removable so that they can be weighed separately from the ROBOT. STANDARD BUMPERS must be attached to the ROBOT with a bolt-and-fastener system to form a rigid, robust connection to the ROBOT structure (i.e. not attached with Velcro!).

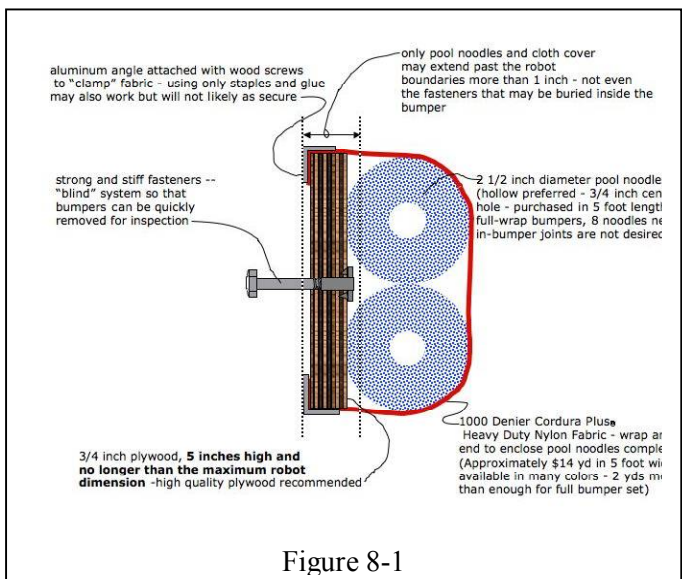

- STANDARD BUMPERS must weigh, in total, no more than 15 pounds including any fasteners that attach them to the ROBOT.
- STANDARD BUMPERS do not have to surround the entire perimeter of the ROBOT, and may be segmented. However, STANDARD BUMPERS must be a minimum of 6 inches in length and can not include sections that weigh more than 3 ounces per inch (i.e. no short bumpers with giant heavy fasteners).
- STANDARD BUMPERS must use a stacked pair of 2-1/2 inch “pool noodles” as the bumper material.
- STANDARD BUMPERS must use 3/4 inch plywood backing 5 inches tall as the bumper structure to attach the bumper (“pool noodles”) to the ROBOT.
- STANDARD BUMPERS must be covered with a tough smooth cloth (1000 denier Cordura Plus® strongly recommended).
- In the STARTING CONFIGURATION, STANDARD BUMPERS may extend outside the horizontal dimensions for the ROBOT (as specified in Rule <R07>) by up to a maximum of 3-1/2 inches per side. Nothing other than pool noodles and cloth can extend more than 1 inch beyond the ROBOT boundaries.
- Hard bumper parts MUST NOT extend into the corners.
- STANDARD BUMPERS must remain within the BUMPER ZONE when the ROBOT is resting on the floor in PLAYING CONFIGURATION. They can not be articulated or moved outside of the BUMPER ZONE. The one exception to this is STANDARD BUMPERS may be within or below the BUMPER ZONE during the END GAME if the ROBOT is in its HOME ZONE (see Figure 8-3).
- For the purposes of the shipping deadlines, STANDARD BUMPERS are considered part of the ROBOT, and must be shipped in the crate with the ROBOT.

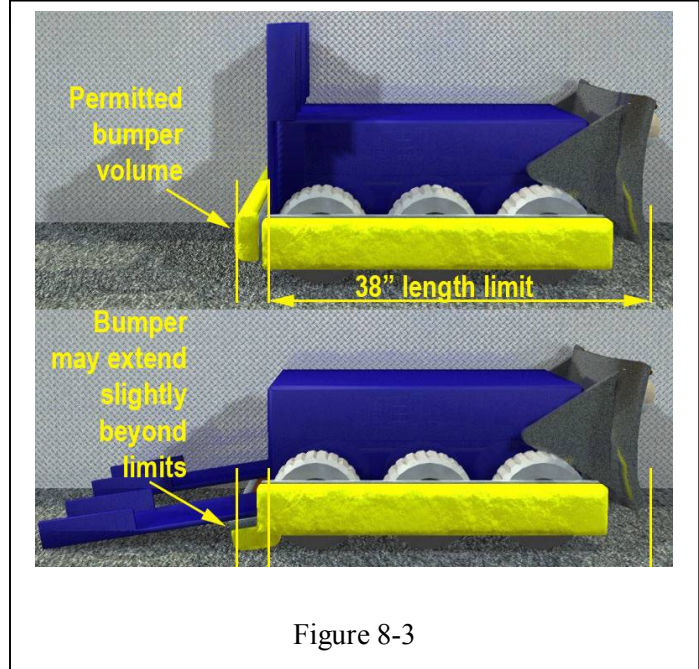
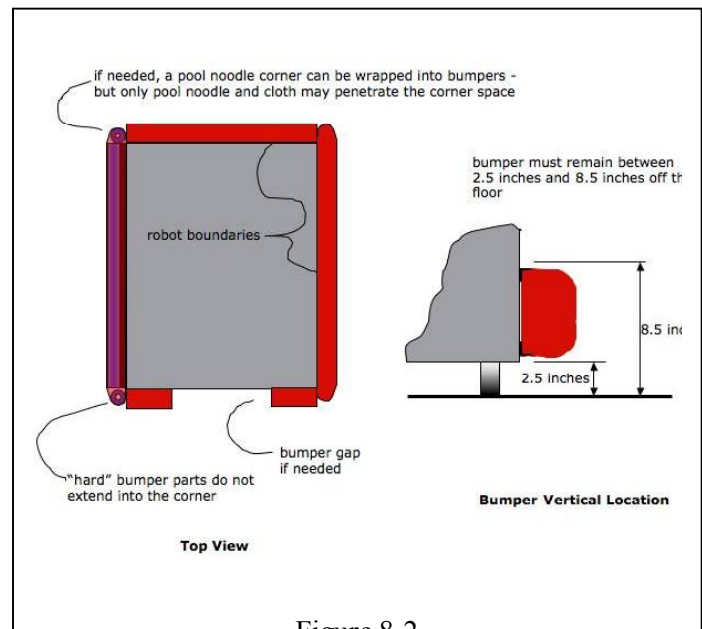

Bumper height has been specified so that ROBOTS will make contact bumper-to-bumper and so that the GAME PIECES will be pushed rather than pulled under the ROBOTS. Note that ROBOT wheel/tracks must be properly positioned relative to any bumpers to avoid interference issues when elevating ROBOTS during the END GAME. As bumper mounts are being designed, please

consider how the ROBOT will be carried (bumpers typically do not make good handles!). Also, note that the use of STANDARD BUMPERS may preclude the use of other technologies in their out-of-the-box configurations. Teams will need to carefully consider the interactions between available bumper options and other elements of their ROBOT design.

8.3.4.1 Kit Of Parts Rules

<R38> So that every ROBOT'S maximum power level is the same, the motors in the Kit Of Parts can **not be modified in any way**, except as follows:

- The mounting brackets and/or output shaft/interface of the motors may be modified to facilitate the physical connection of the motor to the ROBOT and actuated part.
- The gearboxes for the Fisher-Price, and Globe motors are not considered "integral" and may be separated from the motors. **FIRST will not provide replacements for parts that fail due to modification.**
- The electrical input leads on the motors may be trimmed to length as necessary.

The intent is to allow teams to modify mounting tabs and the like, not to gain a weight reduction by potentially compromising the structural integrity of any motor. The integral mechanical and electrical system of the motor is not to be modified.

<R39> Teams may replace lost or damaged Kit Of Parts COMPONENTS only with identical COMPONENTS of the same material, dimensions, and treatment.

<R40> Materials in the Kit Of Parts can not be changed chemically with the following exceptions:

- Rope ends may be singed to prevent loose ends or to bind them together
- Metal may be heat treated
- Metal may be plated or anodized

8.3.4.2 Additional Parts and Materials Rules

Part of the purpose of the FIRST Robotics Competition is to provide team members with the experience of conceptualizing, designing and constructing their own solution to the challenge posed by the game. This must be a consideration when obtaining MECHANISMS and COTS items as additional parts to use on the ROBOT.

This intent is clearly met when a team obtains a MECHANISM or COTS items that was designed for non-FIRST other than robotic competition purposes, and then modifies or alters it to provide functionality for the ROBOT. For example, if a team obtains a gearbox from a power drill and modifies it to use on the ROBOT, they gain insight into the design of the original gearbox purpose, learn to characterize the performance of the original design, and implement the engineering design process to create their customized application for the gearbox.

However, COTS items that have been specifically designed are in and of themselves as a solution to portion of the FIRST Robotics Competition challenge may or may not fit within the FRC intent, and must be carefully considered. If the item provides general functionality that can be utilized in any of several possible configurations or applications, then it is acceptable (as the teams will still have to design their particular application of the item). However, COTS items that provide a complete "pre-packaged" solution for a major ROBOT function (e.g. a complete manipulator assembly, pre-built pneumatics circuit, or full mobility system) that require no effort other than just bolting it on to the ROBOT are against the intent of the competition, and will not be permitted.

In addition to the items directly supplied in the 2007 Kit Of Parts, teams are allowed to use the following parts and materials in the construction of their ROBOTS.

- <R41> The use of an additional part or material shall not violate any design rule.
- <R42> Additional parts shall not be made from hazardous materials or be unsafe. Materials classified as hazardous by their MSD Sheets are explicitly prohibited. Note that this precludes the use of any flammable gases, including hydrogen gas used by the Green Machine pilot program. Teams should provide MSD Sheets for any materials they use that might be considered questionable during ROBOT inspection.
- <R43> Additional parts must be generally available from suppliers such that any other *FIRST* team, if it so desires, may also obtain them at the same price. A specific device **fabricated by a team** from non-2007 Kit Of Parts materials for their use does not have to be available to others; however, the materials it is made from must be available to other teams.
- <R44> The costs of all additional parts and materials must be in compliance with the Cost Accounting Rules of Section 8.3.4.3.
- <R45> Items specifically permitted on 2007 FRC ROBOTS include:
- Additional HITEC HS-322HD Servos.
 - Additional Victor 884 speed controllers and Spike relay modules, as needed.
 - One additional 4-slot Maxi-block circuit breaker panel and utilize it on their 2007 ROBOT in addition to, or in replacement of, the circuit breaker panels provided in the Kit Of Parts.
 - One or two additional 2-1/2" CIM motors (part #FR801-001 and/or M4-R0062-12) in addition to those provided in the Kit Of Parts. This means that up to four, and no more, 2-1/2" CIM motors can be used on the ROBOT.
 - One additional 3" CIM "Minibike" motor (part #FR801-005). This means that up to two, and no more, 3" CIM "Minibike" motors can be used on the ROBOT.
 - Additional solenoid valves, air cylinders, and connecting fittings.
 - One or two additional Clippard air storage tanks (Clippard Part Number AVT-32-16), equivalent to those provided in the kit. This means that up to four, and no more, Clippard air storage tanks can be used on the ROBOT.
 - Pneumatic pressure relief valves identical to those provided in the Kit Of Parts (Parker Part Number PV609-2).
- <R46> Items specifically PROHIBITED from use on the robot during competition matches include:
- Primary 12v batteries different from those provided in the KOP
 - More than one primary battery, or more than one back-up battery
 - Circuit breakers different from those provided in the Kit Of Parts. Note: the Snap Action brand circuit breakers provided have unique "trip" characteristics. No substitute brands are permitted.
 - Fuse panels different from those provided in the Kit Of Parts.

- Electric motors different from, or in addition to, those in the Kit, with the exception of those specifically permitted by Rule <R45>.
- Any air compressor other than the one provided in the Kit Of Parts.
- Hydraulic fluids or hydraulic components.
- Lasers of any type.
- Speakers, sirens, air horns, or other audio devices that generate sound at a level sufficient to be a distraction or hindrance affecting the outcome of a match.
- Electric solenoid actuators (note: electric solenoid actuators are NOT the same as pneumatic solenoid valves – the latter are permitted, the former are not).

<R47> Additional electronic components for use on the ROBOT must be either COTS items, or assembled from COTS items. Additional electronic components include any object that intentionally conducts electricity, other than IFI relays and speed controllers, wires, connectors, solder, and fabricated printed circuit boards.

<R48> Refer to the 2007 Parts Use Flowchart to help determine the legality of a part.

START HERE
May we use a part or material on our robot?

2007 Parts Use Flowchart

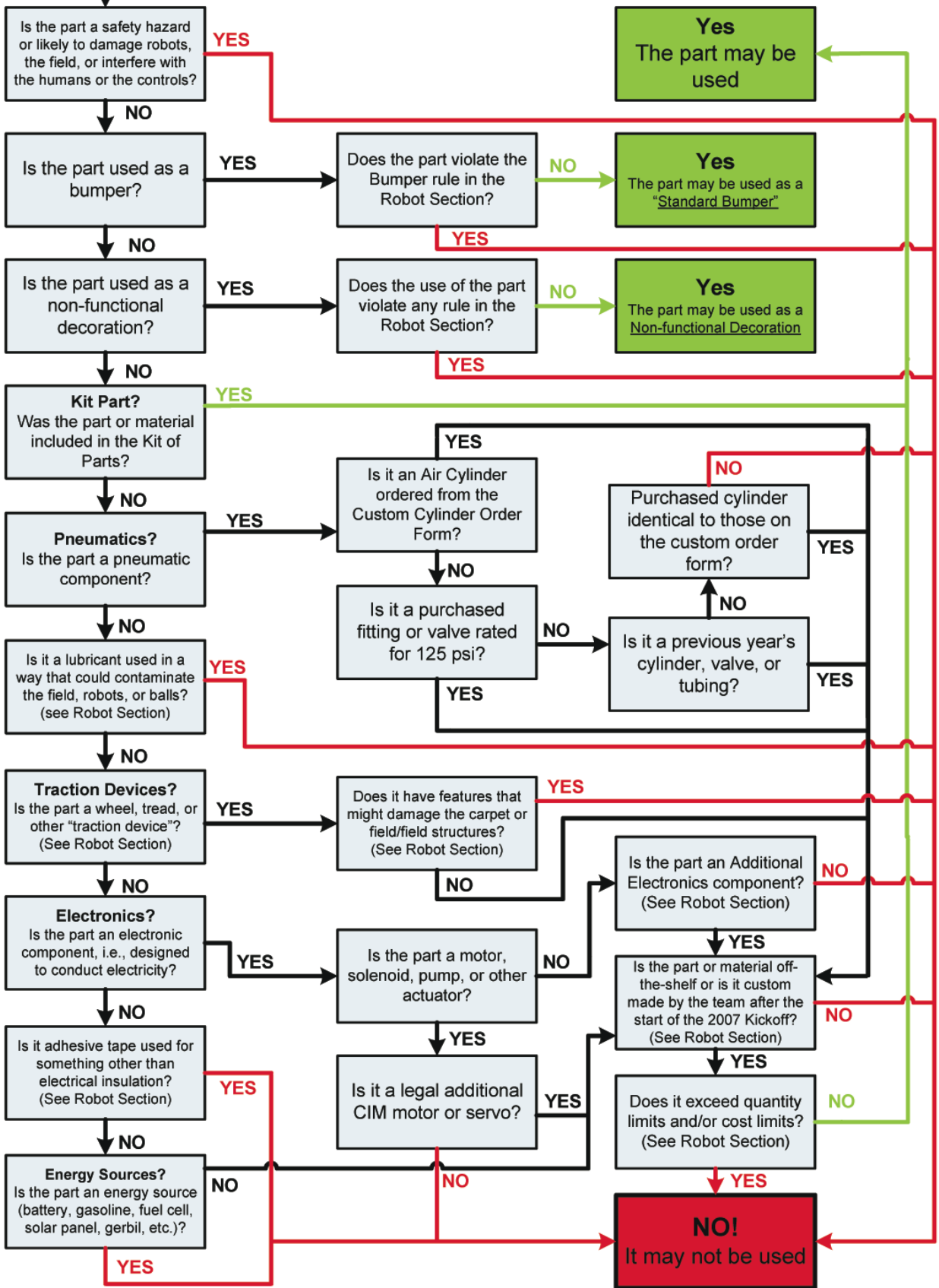

8.3.4.3 Cost Accounting Rules

- <R49>** The costs of all non-2007 Kit parts and materials used in the construction of a ROBOT (as defined in Section 8.1.1) must be recorded (in US dollars) by the team, and a list of all such items and their costs presented at ROBOT inspection.
- <R50>** All costs are to be determined as explained in Section 8.3.4.4 - Additional Parts - Cost Determination.
- <R51>** The total cost of all non-Kit Of Parts items must not exceed \$3,500.00 USD. No individual item shall have a value of over \$400.00. The total cost of components purchased in bulk may exceed \$400.00 USD as long as the cost of an individual component does not exceed \$400.00. The following items are EXCLUDED from the total cost calculation:
- The cost of any non-functional decorations
 - The cost of individual fasteners, adhesives, or lubricants, unless any one component exceeds \$1.00
 - The costs of SPARE PARTS. A SPARE PART used as a direct replacement for a failed or defective ROBOT part (either Kit part or non-Kit part) that has already been included in the cost accounting is covered by the accounting for the original part
 - All costs for the construction of the OPERATOR CONSOLE
- <R52>** The costs of additional non-spare robot control system components obtained from Innovation First Inc. are to be included in the above \$3500.00 limit.

8.3.4.4 Additional Parts - Cost Determination

The "cost" of each additional item is calculated based on the following criteria, as applicable:

- The purchase price of a COTS item offered for sale by a VENDOR to any customer.
- The total cost (materials + labor) of an item you pay someone else to make.
 - Example: A team orders a custom bracket fabricated by a VENDOR to the team's specification. The VENDOR'S material cost and normally charged labor rate apply.
- The fair market value of an item obtained at a discount or as a donation. Fair market value is that price at which the supplier would normally offer the item to other customers. Also considered to be "fair market value" are the discounted prices offered to all teams by suppliers with established relations with *FIRST*.
 - Example: Special price discounts from MSC Industrial Supply Co. and Terminal Supply Co. are being offered to all *FIRST* teams. The discounted purchase price of items from these sources would be used in the additional parts accounting calculations.
- The cost of raw material obtained by a team + the cost of non-team labor expended to have the material processed further. Labor provided by team members and/or by a recognized team sponsor whose employees are members of the team does not have to be included. Note: it is in the best interests of the teams and *FIRST* to form relationships with as many organizations as possible. Teams are encouraged to be expansive in recruiting and including organizations in their team, as that exposes more people and organizations to *FIRST*. Recognizing supporting companies as sponsors of, and members in, the team is encouraged - even if the involvement of the sponsor is solely through the donation of fabrication labor.

- Example: A team purchases steel bar stock for \$10.00 and has it machined by a local machine shop. The machine shop is not considered a team sponsor, but donates two hours of expended labor anyway. The team must include the estimated normal cost of the labor as if it were paid to the machine shop, and add it to the \$10.00.
- Example: A team purchases steel bar stock for \$10.00 and has it machined by a local machine shop that is a recognized sponsor of the team. The machinists are considered members of the team, so their labor costs do not apply. The total applicable cost for the part would be \$10.00.
- The cost of items purchased in bulk or large quantities may be prorated on the basis of the smallest commonly available unit that satisfies the need for the item.
 - Example: A team purchases a 4' x 4' sheet of aluminum, but only uses a piece 10" x 10" on their ROBOT. The team identifies a source that sells aluminum sheet in 1' x 1' pieces. The team may cost their part on the basis of a 1' x 1' piece, even though they cut the piece from a larger bulk purchase. They do not have to account for the entire 4' x 4' bulk purchase item.
- Shipping costs of Non-Kit items are not counted.
- COMPONENTS or MECHANISMS that teams purchase to replace Kit Of Parts items that were not received from *FIRST* are not subject to the cost limitation (i.e., should not be charged against the \$3,500.00 robot limit).
- If the item is part of a modular system that can be assembled in several possible configurations or applications, then each individual module must fit within the price constraints defined in Rule <R51>. If the modules are designed to assemble into a single configuration, and the assembly is functional in only that configuration, then the total cost of the complete assembly including all modules must fit within the price constraints defined in Rule <R51>.

8.3.5 Electrical System Rules

- <R53> The only legal main source of electrical energy on the ROBOT during the competition is the 12VDC non-spillable lead acid battery provided in the 2007 Kit Of Parts. That 12V battery is the MK Battery, ES17-12. Additional batteries may be purchased through a local MK Battery supplier. Teams may use other equivalent 12V batteries during development, testing and practice matches. However, during the qualifier and elimination matches, only the MK Battery, ES17-12 can be used (**this means NO pre-2007 batteries can be used during qualification and elimination matches at any official 2007 *FIRST* competition**).
- <R54> The ES17-12 can only be charged between matches by a 6-ampere rated automatic battery charger. When recharging the Kit Of Parts batteries, either the charger provided by *FIRST* or an automatic charger with an equivalent charging current rating may be used.
- <R55> The 7.2v “backup” battery is considered an integral part of the Robot Controller, and can not be used for any other purpose.
- <R56> The 7.2v backup battery may be charged on or off the ROBOT. When off the ROBOT, the battery is to be charged with a 7.2V backup battery charger. When mounted on the ROBOT, the backup battery may only be charged from the 12VDC primary battery using the Battery Charging Circuit available from Innovation First Inc. (note: IFI will provide the design for this circuit on the IFI website, however teams must obtain the parts for this circuit and assemble it themselves). The use of this circuit is strongly encouraged.

- <R57> The 12V battery, the main 120-amp circuit breaker, the power distribution block, and circuit breaker distribution panels must be connected as shown in the *2007 Power Distribution Diagram*. In particular:
- The battery must be connected to the ROBOT power system through the use of the Anderson Power Products (APP) connector.
 - The APP connector must be attached to the battery with either the copper lugs provided in the FCI Burndy Bag or appropriate crimp-on lug connectors.
 - The battery terminals and the connecting lugs must be insulated with shrink tubing and/or electrical tape.
 - The main 120-amp circuit breaker must be directly connected to the hot (+) leg of the ROBOT-side APP connector. Only one 120 amp main circuit breaker is allowed. This breaker must not be bypassed.
 - The power distribution block must be directly connected to the APP connector and main 120-amp circuit breaker. No other loads may be connected to the main 120-amp circuit breaker.
 - All circuit breaker distribution panels must be connected directly to the power distribution block. No intermediate connections are permitted.
 - Additional lengths of #6 red and #6 black wire may be used to reach the panels as needed to make the above connections.
 - Circuit breakers must be accessible for inspection at each *FIRST* Robotics Competition event.
- <R58> All wiring and electrical devices must be electrically isolated from the ROBOT frame; the ROBOT frame must not be used to carry electrical current (this isolated ground arrangement is necessary due to polarity reversals that occur under certain operating conditions such as during motor direction reversals).
- <R59> All 12v electric power used on the ROBOT must be obtained from the load terminals of the circuit breaker distribution panels. Each branch circuit must be protected using the appropriate value circuit breaker as specified in Section 8.3.9.1 "Circuit Breaker/Fusing Rules."

8.3.6 Custom Circuit Rules

- <R60> The use of additional electronics is intended to allow teams to construct custom circuits for their ROBOTS. The custom circuits may be used to indirectly affect the robot outputs by providing enhanced sensor feedback to the Robot Controller to allow it to more effectively decide how to control the ROBOT. In addition to the required branch power circuit breaker, smaller value fuses may be incorporated in the custom circuits for additional protection.
- <R61> All outputs from the custom circuits must connect to the Robot Controller or to other custom circuits. If connected to the Robot Controller, they must connect through the analog inputs, digital I/O, TTL Serial Port, or Program Port only. Custom circuits can not connect to the Robot Controller through any other ports. Custom circuit outputs can not connect to speed controllers, relay modules, or pneumatic valves.
- <R62> Inputs to custom circuits can be connected to the following sources:
- Branch circuit breaker outputs

- Speed controller or relay module outputs
- PWM, relay or digital outputs on Robot Controller
- Switches, potentiometers, accelerometers, sensors, and other additional permitted electronics.

<R63> Custom Circuits can **not**:

- Interfere with the operation of other ROBOTS.
- Directly alter the power pathways between the battery, fuse blocks, speed controllers, relays, or motors. Custom high impedance voltage monitoring or low impedance current monitoring circuitry connected to the ROBOT'S electrical system is acceptable, because the effect on the ROBOT outputs should be inconsequential.
- Directly affect any output devices on the ROBOT, such as by providing power directly to a motor, supplying a PWM signal to a speed controller or supplying a control signal to a relay module.
- Be used for wireless communication, such as sending or receiving a signal to and/or from the alliance station.
- Connect to the radio or tether ports on the Robot Controller

8.3.7 Control System Rules

<R64> ROBOTS must be operated via the wireless, programmable Innovation First 2007-Robot Control System.

<R65> The control system is provided to allow wireless control of the ROBOTS. The Operator Interface, Robot Controller, speed controllers, relay modules, radio modems, batteries, battery charger, AC adapter, and 9-pin cables can not be tampered with, modified, or adjusted in any way, (tampering includes drilling, cutting, machining, gluing, rewiring, etc.) with the following exceptions:

- Dip switches on the Operator Interface may be set as appropriate.
- User programmable code in the Robot Controller may be customized.
- Speed controllers may be calibrated as described in owner's manuals.
- The fuse on the Spike relay for the air compressor may be replaced with a 20 Amp Snap-Action circuit breaker.

<R66> The radio modems provided in the 2007 Kit Of Parts are the only permitted method for communicating with the ROBOTS during the competition. Radio modems from previous *FIRST* competitions can not be used. The radio modem must be connected directly to the Robot Controller using one of the DB-9 cables provided in the 2007 Kit Of Parts. No other form of wireless communications can be used to communicate to, from or within the ROBOT (e.g. no Bluetooth devices are permitted on the ROBOT).

<R67> Teams are responsible for any software bugs introduced into the Robot Controller's control program when using a custom program or for any unwanted or unanticipated ROBOT behavior when using additional electronics.

- <R68> The Robot Controller must be positioned within the ROBOT so that its indicator lights can be seen during inspection and when standing three feet in front of the ROBOT while the ROBOT is in the STARTING CONFIGURATION at the beginning of a match. This will greatly facilitate analysis in case of problems.

- <R69> All electrical loads (motors, actuators, compressors) must be controlled by relay or PWM output signals sent by the Robot Controller to relay modules or speed controllers. Every speed controller and relay module must be connected via PWM cable to the Robot Controller, and be controlled by signals provided by the Robot Controller. They can not be controlled by signals from any other source.

- <R70> The team number settings on the Operator Interface must be set to the team number assigned to the team by *FIRST*, then the Robot Controller must be tethered to the Operator Interface to transfer the Team Number setting to the Robot Controller. This must be done every time changes are made to the team number setting on the Operator Interface.

- <R71> Do not connect 12Vdc power, relay module outputs, speed controller outputs, or PWM outputs to the analog or digital I/O on the Robot Controller.

- <R72> All outputs from the sensors and additional electronics circuits used on the ROBOT must be connected directly to other custom circuits or the analog or digital I/O on the Robot Controller. It is acceptable to wire switches used as sensors in series or parallel with each other.

- <R73> The 7.2V Robot Control backup battery must be connected to the Robot Controller as described in the Robot Controller manual. The 7.2v battery should be charged to at least 7.0v before entering a match. As a replacement for the *FIRST* supplied battery, any other commercially available 7.2V NiCad battery pack may be used.

- <R74> A remote reset and remote programming switch may be wired to the Robot Controller RESET/PROG header. Any switch may be used. See the *Robot Controller Reference Guide* for wiring information.

- <R75> Digital outputs of the Robot Controller may be connected directly to brake/coast headers on the speed controllers to permits programmable control of this speed controller function. The brake/coast header on the speed controller may NOT be connected to any other circuit or input.

- <R76> Unaltered software modules developed during prior competitions can not be directly re-used. Just as designs for hardware COMPONENTS may be reused from one year to the next, software algorithms and designs may be reused. However, the specific lines of code must be customized for each ROBOT each year.

8.3.8 Operator Interface Rules

- <R77> The team number settings on the Operator Interface must be set to the team number assigned to the team by *FIRST*.

- <R78> The OPERATOR CONSOLE designed by the team must fit on the 60" wide by 12" deep shelf in the Alliance Station (excluding any items that are held or worn by the DRIVERS during the match).

- <R79> Teams are permitted to connect a portable computing device (Laptop computer, PDAs, etc.) to the RS232 Output of the dashboard port of the Operator Interface for the purpose of displaying feedback from the ROBOT while participating in competition matches. Please note that ***AC power will not be available at the playing field so these devices will have to run on internal batteries.***
- <R80> The Operator Interface must be positioned within the OPERATOR CONSOLE so that the indicator lights can be clearly seen during inspection and during operation in a match. The ports on the Operator Interface must be easily and quickly accessible. This will greatly facilitate analysis by field personnel in case of problems during the competition.
- <R81> Teams cannot use Operator Interfaces from previous years' competitions.
- <R82> Nothing can be connected to the tether port of the Operator Interface during a match.
- <R83> All equipment connected to the joystick ports of the Operator Interface must be powered solely through the power available through the port. External power sources of any type are not permitted on any equipment connected to the joystick ports. Portable computing devices *can not* be connected to joystick input ports on the Operator Interface. Power-passive devices (e.g. joysticks that draw their power solely through the Operator Interface joystick port) are permitted. The one exception to this rule is Innovation First Incorporated USB adapters (IFI Part Number USB-CHICKLET) may be used to connect USB devices to the joystick ports of the Operator Interface. If used, this USB adapter must be powered with a 7.2V battery similar to the back-up battery. Teams can not use power from the competition port or any other source to power the USB adapter. The USB adapter must be positioned within the OPERATOR CONSOLE so that the indicator lights may be seen during inspection and operation in a match.
- <R84> The competition cable at the Alliance Station must connect directly to the competition port on the Operator Interface. No intermediate connectors, cables, or "pigtailed" are permitted.

8.3.9 Wiring Rules

- <R85> Electrical devices must be wired in accordance with *Section 8.3 Robot Rules*, using commercially available copper wire for all electrical connections. Aluminum (or other non-copper material) wire is prohibited. For examples of acceptable circuit designs, please see the *2007 Robot Power Distribution Diagram*.
- <R86> All wires distributing power with a constant polarity (i.e., except for relay module, speed controller, or sensor outputs) must be color-coded as follows:
- Use red, white, or brown wire for +12 Vdc and +5 Vdc connections.
 - Use black or blue wire for common (-) connections.
- <R87> *12 AWG or larger* diameter wire must be used for all circuits protected by a 40A circuit breaker.
- <R88> *14 AWG or larger* diameter wire must be used for all circuits protected by a 30A circuit breaker.

- <R89> 18 AWG or larger diameter wire must be used for all circuits protected by a 20A circuit breaker.
- <R90> 24 AWG or larger diameter wire must be used for connecting sensors such as: switches, potentiometers, accelerometers, and other sensors. 24 AWG or larger diameter wire must be used for connecting a vision system to Robot Controller inputs, and for extending the PWM cables, for the small muffin fans, or for wiring LEDs. It is acceptable to use ribbon cable smaller than 24 AWG to connect to the 9 pin ports on the Robot Controller.
- <R91> Each motor, actuator, and compressor must be connected to one, and only one, speed controller or relay module.
- <R92> CIM motors and Fisher-Price motors must be connected to speed controllers. They can not be connected to relay modules.

8.3.9.1 Circuit Breaker / Fusing Rules

- <R93> The auto resetting Snap Action circuit breakers provided in the Kit Of Parts must be used to protect all active circuit breaker/ power distribution panel branch circuits from overload.
- <R94> The Robot Controller power feed must be protected with a 20A circuit breaker. No other electrical load can be connected to this breaker.
- <R95> The air compressor spike relay power feed must be protected with a 20A circuit breaker. No other electrical load can be connected to this breaker.
- <R96> Power feeds to custom circuits and additional electronics must be protected with a 20A circuit breaker.
- <R97> Speed controllers may be protected by 20A, 30A, or 40A circuit breakers. Speed controllers may power motors or devices of any size.
- <R98> Relay modules must be protected with a 20A circuit breaker. Multiple devices may be connected to relay modules if desired (but only one motor may be connected to each relay module).

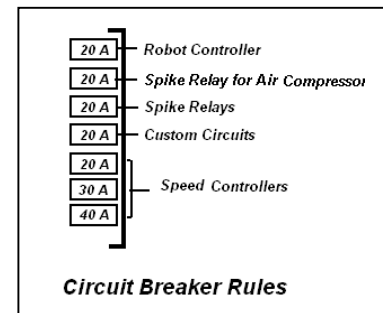

8.3.10 Pneumatic System Rules

Please refer to the *Pneumatics Manual* for additional information about using pneumatics on your ROBOT.

- <R99> Pneumatic components supplied in the Kit Of Parts (compressor, regulators, pressure switches, cylinders, valves, fittings, tubing, etc.) can not be modified except as follows:
 - The tubing may be cut.
 - The wiring for the valves and pressure switch may be modified as necessary to interface with the rest of the control system.

- Mounting and connecting pneumatics components using the pre-existing threads, mounting brackets, etc., is not considered a modification of the components. Removing the pin from the rear of an air cylinder is allowed as long as the cylinder itself is not modified.
- Do not, for example, file, machine, or abrasively remove any part of an air cylinder. Consider pneumatic components sacred. They must remain in “out of the shipping box” condition.

<R100> If pneumatics are used on the ROBOT, the pneumatic system on the ROBOT must contain as a minimum the following components, connected in accordance with this section.

- Pressure gauges to display the “working” and “stored” air pressure.
- An easily visible and accessible pressure vent valve to manually relieve the stored pressure.

<R101> The compressor may be mounted on the ROBOT, or it may be left off the ROBOT and used to pre-charge compressed air in the storage tanks prior to bringing the ROBOT onto the playing field. Off-board compressors must be controlled and powered by the ROBOT. The only difference between an on- and off-board compressor is that the off-board compressor is physically removed from the ROBOT. Note: the intent of this rule is to permit teams to take advantage of the weight savings associated with keeping the compressor off-board. But using the compressor off-board of the ROBOT does NOT permit non-compliance with any other applicable rules.

<R102> **Teams are not allowed to remove or adjust the 125-psi set relief valve attached to the compressor.** Only use the Thomas Industries compressor and up to four Clippard Instruments air storage tanks identical to those provided in the Kit can be used to compress and store air on the ROBOT. Extraneous lengths of pneumatic tubing can not be used to increase the storage capacity of the air storage system.

<R103> The Nason pressure switch must be connected to the output end of one of the Clippard tanks to sense the tank’s pressure. The two wires from the pressure switch must be connected directly to a digital input and ground terminal on the Robot Controller, and the controller must be programmed to sense the state of the switch and operate the relay module that powers the compressor. The Parker pressure vent valve must be connected to a Clippard tank such that, when manually operated, it will vent to the atmosphere to relieve any stored pressure. The valve must be placed on the ROBOT so that it is visible and accessible.

<R104> “Working” air pressure on the ROBOT must be no greater than 60psi. All working air must come from the Norgen adjustable pressure regulator, and all other pneumatic components must be downstream from this regulator. A pressure gauge must be placed adjacent to the pressure regulator and display the downstream pressure.

<R105> There is no limit to the number of solenoid valves, air cylinders, pressure regulators, and connecting fittings that may be used on the ROBOT. They must, however, be “off the shelf” pneumatic devices rated by their manufacturers for pressure of at least 125psi. Besides the “free” pneumatic components listed on the Pneumatic Components Order form, additional air cylinders or rotary actuators may be purchased. However, they must be identical to those listed on the Pneumatic Components Order form (i.e. same part numbers), and obtained from a Bimba or Parker Hannifan distributor.

<R106> The following pneumatics items may be added to the ROBOT:

- Prior year *FIRST* Kit Of Parts pneumatic cylinders, solenoid valves, and pneumatic tubing may be used in addition to those items in the 2007 Kit Of Parts. Their costs must be accounted for explained in **Section 8.3.4.3 Additional Parts - Cost Limits and Accounting.**
- A pressure transducer may be used as long as it is rated to the operating air pressure at its mounting point in the pneumatic system.
- For the purposes of the *FIRST* competition, a device that creates a vacuum is not considered to be a pneumatic device and is allowed. This includes, but is not limited to, Venturi-type vacuum generators and off-the-shelf vacuum devices (as long as they are powered by one of the Kit-of-Parts motors).
- For the purposes of the *FIRST* competition, closed-loop pneumatic (gas) shocks are not considered pneumatic devices, and are permitted additions to the ROBOT.
- Additional pressure relief valves, as needed, as long as they are identical to those supplied in the Kit Of Parts (Parker Part Number PV609-2).
- Additional 1/8 inch diameter pneumatic tubing functionally equivalent to that provided in the Kit Of Parts, with the pressure rating clearly factory-printed on the exterior of the tubing (note: alternate tubing colors are acceptable).

8.3.11 Non-Functional Decoration Rules

Teams may add “non-functional” decorations to ROBOTS under the following conditions:

- <R107> Decorations must be on the ROBOT at the time of final inspection, and must not cause the ROBOT weight or size to exceed the limits specified in Rule <R07>.
- <R108> Decorations must not affect the outcome of the match, and must be in the spirit of “Gracious Professionalism.”
- <R109> Any decorations that involve broadcasting a signal to/from the ROBOT, such as remote cameras, must be cleared with *FIRST* Engineering prior to the event and tested for communications interference at the venue. This is the one permissible exception to Rule <R66>. Note that 900 MHz camera systems will not be approved, and are not permitted at any time.
- <R110> Decorations may draw power from the 12v electrical system as long as they are powered via a dedicated 20A or 30A circuit breaker and do not affect the operation of other control system components.

8.3.12 Robot Inspection Rules

FIRST will post a copy of the Official Robot Inspection Sheet by January 19, 2007. Use this sheet as a guide to pre-inspect your ROBOT before it ships. Note that robot inspectors will be looking for sharp corners and edges that could cause injury, pinch points, entanglement hazards, and impaling projections. Please try to mitigate all such hazards.

- <R111> All ROBOTS must pass inspection for compliance with the rules herein before being allowed to compete in qualification matches. At the time of inspection, teams must present a list of all Non-Kit Of Part items and costs used in the construction of their ROBOT to the inspector.

- <R112> At inspection, noncompliance with any robot construction rule may result in disqualification of the ROBOT from the *FIRST* competition event. The team must bring the ROBOT into compliance before they will be allowed to compete in qualification matches. At the discretion of the lead Inspector, the ROBOT may be allowed to participate in practice matches before passing inspection.
- <R113> If a team makes a modification to improve performance or reliability after their ROBOT has passed inspection, that team must have the ROBOT re-inspected. If an observation is made that another team's ROBOT may be in violation of the robot rules, please approach *FIRST* officials to review the matter in question. This is an area where "Gracious Professionalism" is very important.
- <R114> At the time of inspection, the ROBOT must be presented with **all** mechanisms (including **all** components of each mechanism) **and configurations** that will be used on the ROBOT during the entire competition event. It is acceptable, however, for a ROBOT to play matches with a **subset** of the mechanisms that were present during inspection. Only mechanisms that were present during the inspection may be added, removed or reconfigured between matches. If subsets of mechanisms are changed between matches, the reconfigured ROBOT must still meet all inspection criteria.
- <R115> If a ROBOT is rejected because of a safety issue or concern related to the team's method of storing energy (see Rule <R02>), the concerned mechanisms must be disabled or removed from the ROBOT before it can compete in a match. The team bears the burden of proof that such a rejection is not valid. Teams should be prepared to provide justifiable test data or calculations during inspection to support their design.
- <R116> *FIRST* Officials may randomly re-inspect ROBOTS participating in competition matches to assure compliance with the rules.

THE TOURNAMENT**TABLE OF CONTENTS**

9 THE TOURNAMENT	2
9.1 OVERVIEW	2
9.2 PRACTICE MATCHES.....	2
9.2.1 Schedule.....	2
9.3 QUALIFICATION MATCHES	2
9.3.1 Schedule.....	2
9.3.2 Match Assignment	2
9.3.3 Earning Points.....	2
9.3.4 Match Qualifying Points	3
9.3.5 Match Ranking Points	3
9.3.6 Match Point Exceptions	3
9.3.7 Qualifying Score.....	3
9.3.8 Ranking Score	3
9.3.9 Highest Match Score.....	3
9.3.10 Qualification Seeding.....	4
9.4 ELIMINATION MATCHES	4
9.4.1 Alliance Selection Process.....	4
9.4.2 Elimination Match Pit Crews	5
9.4.3 Backup Teams	5
9.4.4 Elimination Match Ladder	5
9.4.5 Elimination Scoring	6
9.5 CHAMPIONSHIP PLAYOFF ADDITIONS	6
9.5.1 Championship Pit Crews.....	6
9.5.2 Championship Backup Teams	6
9.5.3 FRC Championship Match Ladder.....	7
9.6 TOURNAMENT RULES	7
9.6.1 Safety Rules.....	7
9.6.2 Referee Interaction Rules	7
9.6.3 Yellow and Red Card Rules	8
9.6.4 Field Reset Rules.....	8
9.6.5 Time-out and Backup Team Rules.....	9
9.6.6 Special Equipment Rules.....	9

9 THE TOURNAMENT

9.1 OVERVIEW

Each 2007 FRC Regional Competition and the 2007 FRC Championship will be played in a tournament format. Each tournament will consist of three sets of matches called “practice matches,” “qualification matches,” and “elimination matches.” The purpose of the practice matches is to allow each team a chance to run its ROBOT on the playing field prior to the start of the competition matches. The purpose of the qualifying matches is to allow each team to earn a seeding that may qualify them for participation in the elimination matches. The purpose of the elimination matches is to determine the event Champions.

For the 2007 FRC Championship, teams will be split into four divisions. Each division will play exactly like a Regional Event and produce the Division Champions. Those four ALLIANCES will then proceed to the Championship Playoffs to determine the 2007 FRC Champions.

9.2 PRACTICE MATCHES

9.2.1 Schedule

The practice matches will be played all day on the first day of each competition. The practice match schedule will be available on the first morning. Practice matches will be randomly assigned. Each team will be assigned an equal number of practice matches. At some events, additional matches may be available on a standby basis. Each practice match will consist of a ten-minute period in which teams may operate their ROBOT on the field. The first five minutes of each practice match will start with a 15-second autonomous period, and followed by a “free-form” session, in which the ROBOTS may be exercised to evaluate operational characteristics, gain driver experience, determine system robustness, etc. The second five minutes of each practice match will be conducted as a “competition match” with approximately two minutes for set up, two minutes and fifteen seconds of regular game play (including autonomous operations), and one minute to clear the field.

9.3 QUALIFICATION MATCHES

9.3.1 Schedule

The qualification matches will be played all day on the second day of the competition and finish on the third morning at approximately noon. The qualification matches will consist of a series of matches, with an arena reset between each match. The qualification match schedule will be available on the second morning of the competition

9.3.2 Match Assignment

The scoring system will randomly assign each team two ALLIANCE partners for each qualifying match played. All teams will play the same number of qualifying matches **except** if the number of teams in attendance is not divisible by six; in that case the scoring system will randomly select some teams to play an extra match. For purposes of seeding calculations, those teams will be designated as SURROGATES for the extra match.

9.3.3 Earning Points

At the conclusion of each match, each participating team will earn both qualifying points and ranking points. These will be accumulated during the tournament to determine each team’s qualifying score and ranking score. The scoring system will use the combination of qualifying

score and ranking score to continuously determine the seeding of teams during the qualification matches.

9.3.4 Match Qualifying Points

At the completion of each qualification match, each team will receive a win, loss or tie depending on the final score:

- Each team on the winning ALLIANCE will receive two (2) qualifying points.
- Each team on the losing ALLIANCE will receive zero (0) qualifying points.
- In the event of a tied score, all six teams will receive one (1) qualifying point.

9.3.5 Match Ranking Points

All teams on the winning ALLIANCE will receive a number of ranking points equal to the un-penalized score (the score without any assessed penalties) of the losing ALLIANCE.

All teams on the losing ALLIANCE will receive a number of ranking points equal to their final score (with any assessed penalties).

In the case of a tie, all participating teams will receive a number of ranking points equal to their ALLIANCE score (with any assessed penalties).

9.3.6 Match Point Exceptions

A SURROGATE team will receive zero qualifying points and zero ranking points.

A team is declared a no-show if **no** member of the team is in the ALLIANCE ZONE at the start of the match; a no-show team will be disqualified from that match.

During the qualification matches, teams can be individually disqualified in a match. A disqualified team will receive zero qualifying points and zero ranking points.

In the very unlikely case that all three teams on an ALLIANCE are disqualified, all three teams on the winning ALLIANCE would get their own score as their ranking points for that match.

9.3.7 Qualifying Score

The total number of qualifying points earned by a team throughout their qualification matches will be their qualifying score.

9.3.8 Ranking Score

The total number of ranking points earned by a team throughout their qualification matches, divided by the number of matches played (excluding any SURROGATE matches), then truncated to two decimal places, will be their ranking score. *Note: because your ranking score is derived directly from the match scores of the losing ALLIANCES in the matches you play, it is in your best interest to support your opponents and win by helping each ALLIANCE score as many points as possible.*

9.3.9 Highest Match Score

The scoring system will keep track of the highest match score earned by each team during the qualification matches but this score will not be displayed.

9.3.10 Qualification Seeding

All teams in attendance will be seeded during the qualification matches. If the number of teams in attendance is 'n', they will be seeded '1' through 'n', with '1' being the highest seeded team and 'n' being the lowest seeded team.

The scoring system will use the following seeding method:

- Teams will be broken into tiers based on their qualifying score. A tier is made up of all teams with the same qualifying score. Tiers will be seeded in decreasing order by qualifying score.
- Within each tier, teams will be seeded in decreasing order by their ranking score.
- If any teams within a tier have the same ranking score, they will then be seeded in decreasing order by their highest match score.
- If any teams within a tier have the same ranking score and the same highest match score, then the scoring system will seed those teams based on a random electronic coin toss.

9.4 ELIMINATION MATCHES

At the end of the qualification matches, the top eight seeded teams will become the Alliance Leads. The top seeded ALLIANCES will be designated, in order, Alliance One, Alliance Two, etc., down to Alliance Eight. Using the alliance selection process described below, each team will choose two other teams to join their ALLIANCE.

9.4.1 Alliance Selection Process

Each team will choose a student Team Representative who will proceed to the playing field at the designated time to represent their team. The Team Representative for each Alliance Lead will be the ALLIANCE CAPTAIN.

The alliance selection process will consist of two rounds during which each ALLIANCE CAPTAIN will invite a team seeded below them in the standings to join their ALLIANCE. The invited team must not already have accepted or declined an invitation.

Round 1: In descending order (Alliance One to Alliance Eight) each ALLIANCE CAPTAIN will invite a single team. The invited Team Representative will step forward and either accept or decline the invitation.

If the team accepts, it is moved into that ALLIANCE.

- If an invitation from a top eight ALLIANCE to another Alliance Lead is accepted, all lower Alliance Leads are promoted one spot and the next highest seeded unselected team will move up to become Alliance Eight.

If the team declines, it is not eligible to be picked again and the ALLIANCE CAPTAIN extends another invitation to a different team.

- If an invitation from a top eight ALLIANCE to another Alliance Lead is declined, the declining team may still invite teams to join their ALLIANCE, however, it cannot accept invitations from other ALLIANCES.

The process continues until Alliance Eight makes a successful invitation.

Round 2: The same method is used for each ALLIANCE CAPTAIN'S second choice except the selection order is reversed, with Alliance Eight picking first and Alliance One picking last. This process will lead to eight ALLIANCES of three teams.

9.4.2 Elimination Match Pit Crews

During the elimination matches, extra team members are often needed to move the team ROBOT from the team's pit area to the queuing area and onto the playing field. For this reason, each team is permitted to have three (3) additional "pit crew" members who can also help with needed ROBOT repairs/maintenance.

We suggest that all teams assume they may be chosen for an ALLIANCE and think about the logistics of badge distribution and set a plan prior to the pairings. It is each ALLIANCE CAPTAIN'S responsibility to get their team's badges to the team pit crewmembers.

9.4.3 Backup Teams

Of the remaining eligible teams, the highest seeded teams (up to eight) shall remain on standby and be ready to play as a BACKUP TEAM. If a ROBOT from any team in an elimination match ALLIANCE becomes inoperable the ALLIANCE CAPTAIN is presented the option of having the highest seeded BACKUP TEAM join the ALLIANCE. The resulting ALLIANCE would then be composed of four teams, but only three teams will be permitted to continue with match play. The inoperable team remains part of the ALLIANCE for awards but can not play, even if their ROBOT is repaired.

The original three-team ALLIANCE shall only have one opportunity to draw from the BACKUP TEAMS. If a second ROBOT from the ALLIANCE becomes inoperable, then the ALLIANCE must play the following matches with only two (or even one) ROBOTS. It is in the best interests of all teams to construct their ROBOTS to be as robust as possible to prevent this situation.

- Example: Three teams, A, B and C, form an ALLIANCE going into the elimination matches. The highest seeded team NOT on one of the eight ALLIANCES is Team D. During one of the elimination matches, Team C has their ROBOT disabled. The ALLIANCE CAPTAIN decides to bring up Team D to replace the disabled ROBOT. Team C and their ROBOT may not play in any subsequent elimination matches.

In the case where a BACKUP TEAM is called up onto the winning ALLIANCE, there will be a four-team Champion Alliance.

9.4.4 Elimination Match Ladder

The elimination matches will take place on the third afternoon in a ladder format as follows:

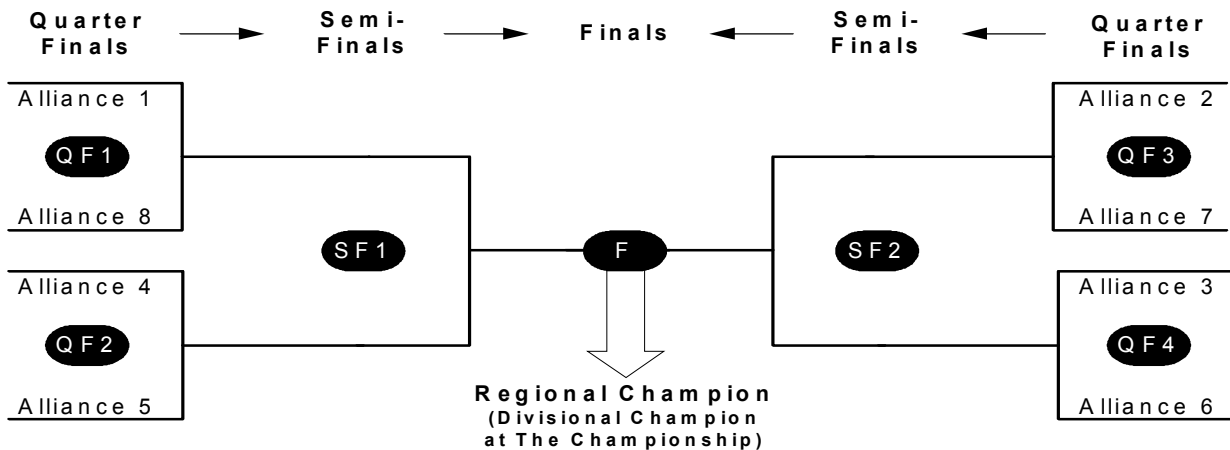

In order to allow equal time between matches for all ALLIANCES, the order of play will be:

QF1-1, QF2-1, QF3-1, QF4-1,
Then QF1-2, QF2-2, QF3-2, QF4-2,
Then QF1-3*, QF2-3*, QF3-3*, QF4-3*
Then any QF replays due to ties*
Then SF1-1, SF2-1, SF1-2, SF2-2, SF1-3*, SF2-3*
Then any SF replays due to ties*
Then F-1, F-2, F-3*
Then any F replays due to ties*

(* - if required)

9.4.5 Elimination Scoring

In the elimination matches teams do not earn qualification points; they earn a win, loss or tie. Any tied matches will be replayed.

Within each bracket of the elimination match ladder, matches will be played to determine which ALLIANCE advances, as follows:

The first ALLIANCE to win two matches advances.

9.5 CHAMPIONSHIP PLAYOFF ADDITIONS

Procedures in Sections 9.1-9.4 apply during the Championship Playoffs, with the following additions:

9.5.1 Championship Pit Crews

Only team members wearing proper badges are allowed on the arena floor. *FIRST* will distribute these badges to the ALLIANCE CAPTAINS during the ALLIANCE CAPTAIN meeting, which takes place on the division fields. These badges will provide the necessary access to the field for pit crewmembers.

9.5.2 Championship Backup Teams

If an ALLIANCE has not previously brought in a BACKUP TEAM, and a ROBOT becomes disabled during the Championship Playoffs and can not continue, the ALLIANCE CAPTAIN will be presented the option of having the lead Division Finalist team from their division join the ALLIANCE as a BACKUP TEAM.

If an ALLIANCE has won their division with a BACKUP TEAM and moved on to the FRC Championship Playoffs, the BACKUP TEAM continues to play for the ALLIANCE in the Championship Playoffs.

As noted in Section 9.4.3, the original three-team ALLIANCE shall only have one opportunity to draw from the BACKUP TEAMS. If the ALLIANCE has brought in a BACKUP TEAM during the division elimination matches or the Championship Playoffs, they cannot bring in a second BACKUP TEAM. If a second ROBOT from the ALLIANCE becomes inoperable during the Championship Playoffs, then the ALLIANCE must play the following matches with only two (or even one) ROBOTS.

In either case, the replaced team remains part of the ALLIANCE for awards but can not rejoin match play, even if their ROBOT is repaired. If the ALLIANCE wins the Championship Playoffs, the FRC Champions will be all three original members of the Division Champion ALLIANCE and the BACKUP TEAM.

9.5.3 FRC Championship Match Ladder

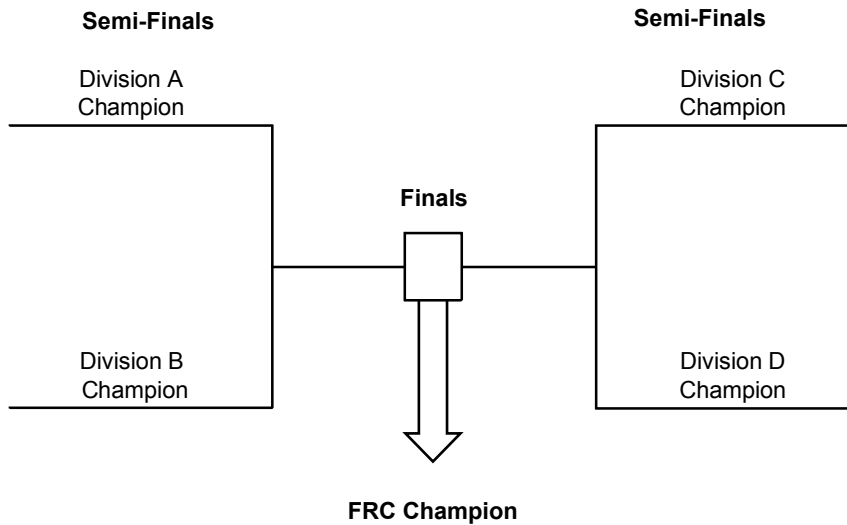

The FRC Championship matches will play exactly like the Semi-Finals and Finals of the elimination matches.

9.6 TOURNAMENT RULES

9.6.1 Safety Rules

- <T01> Teams are responsible for providing their own safety glasses at each event. All team members, including coaches, must wear safety glasses while in the pit or on the play field during matches.
- <T02> All team members must wear appropriate closed-toe footwear while in the pit area or competing on the field. **No bare feet, sandals or open-toed footwear are allowed.**
- <T03> Wireless / radio control mode of ROBOT operation is not permitted in any of the pit areas. ROBOTS can only be operated by tether when not on the competition field.

9.6.2 Referee Interaction Rules

- <T04> The Head Referee has the ultimate authority on the field during the competition. THE HEAD REFEREE RULINGS ARE FINAL! The referee will not review recorded replays under **any** circumstance.
- <T05> If a team needs clarification on a ruling or score, a pre-college student from that team should address the Head Referee after a field reset has been signaled. Depending on timing, the Head Referee may postpone any requested discussion until the end of the subsequent match. Head Referees will only discuss calls, scores, penalties or match outcomes with pre-college team members.

9.6.3 Yellow and Red Card Rules

- <T06> The Head Referee may assign a YELLOW CARD as a warning of egregious ROBOT or team member behavior. This will occur at the completion of a match, before the field is reset, and will be indicated by the Head Referee standing in front of the team's PLAYER STATION and holding a yellow card in the air. In the first match that a team receives a YELLOW CARD, it acts as a warning.
- <T07> After a team receives a YELLOW CARD, a yellow flag will be placed on their ROBOT at the beginning of all subsequent matches as a reminder to the team, the referees and the audience that they have a YELLOW CARD.
- <T08> A team will be issued a RED CARD (disqualification) in any subsequent match that they receive an additional YELLOW CARD. This will occur at the completion of a match, before the field is reset, and will be indicated by the Head Referee standing in front of the team's PLAYER STATION and holding a yellow card and red card in the air simultaneously. The team will still carry their YELLOW CARD into subsequent matches.
- <T09> YELLOW CARDS do not carry forward between qualification matches and elimination matches. All teams move into the elimination matches with a clean slate.
- <T10> If a team is disqualified during a match for a reason other than receiving an additional YELLOW CARD, they will receive a RED CARD. This will occur at the completion of a match, before the field is reset, and will be indicated by the Head Referee standing in front of the team's PLAYER STATION and hold a red card in the air.
- <T11> During the qualification matches, a team that receives a RED CARD will receive zero ranking points and zero qualification points. The rest of the team's in their ALLIANCE will still receive the earned qualification points and ranking points.
- <T12> During the elimination matches, a team receiving a RED CARD will cause the disqualification of their entire ALLIANCE for that match.

9.6.4 Field Reset Rules

- <T13> At the conclusion of a match, all players shall remain in the Player Zone until the Head Referee issues the "field-reset" signal. Once the Head Referee issues this signal, the 3-minute "match-reset" period will begin. During this time, the field must be cleared of ROBOTS from the match just ended, and the ROBOTS and OPERATORS CONSOLES for the following match must be in position and ready to start before the expiration of the "match-reset" period. Field Attendants will reset the field elements during this time.
- <T14> Field power to the ROBOTS will **not** be re-enabled after a match. ROBOTS must be designed to permit removal of GAME PIECES or other ROBOTS without requiring activation of the ROBOT power system. Teams should design mechanisms that allow easy release of GAME PIECES. At the discretion of the head referee or field manager, ROBOTS may be powered up and controlled via tether to collapse the ROBOT to permit safe and/or rapid removal from the field and transport to the pits. Teams that power up to collapse their ROBOTS must do so in a timely manner. For information on using the tether, please refer to the control system documentation from Innovation First.
- <T15> The qualification match schedule will indicate ALLIANCE partners and match pairings. It will also indicate the ALLIANCE color assignment, RED or BLUE, for each match. The color is used to determine the placement of each team's ROBOT, drivers, human players, and coach around the playing field.
- <T16> The higher seeded ALLIANCE will have the last opportunity to orient their ROBOTS within the selected locations.

<T17> If, in the judgment of the Head Referee, a “field fault” occurs that affects either the play or the outcome of the match, the match will be replayed. Example field faults include broken field elements, power failure to a portion of the field, improper activation of the field control system, errors by field personnel, etc.

9.6.5 Time-out and Backup Team Rules

- <T18> There are **no** time-outs in the qualifying rounds. If a ROBOT cannot report for a match, the queuing manager must be informed and at least one member of the team should report to the field for the match to avoid disqualification.
- <T19> During the elimination rounds, if circumstances require an ALLIANCE to play in back-to-back matches, they will be granted an additional minute of set-up time to reset and allow their ROBOTS to cool down.
- <T20> In the elimination matches, each ALLIANCE will be allotted one TIME-OUT of up to 6 minutes. If an ALLIANCE wishes to call for a TIME OUT, they must submit their TIME OUT coupon to the Head Referee within two minutes of the Head Referee issuing the field reset signal preceding their match. When this occurs, the Time-out Clock will count down the six minutes starting with the expiration of the arena-reset period. Both ALLIANCES will enjoy the complete 6-minute window. In the interest of tournament schedule, if an ALLIANCE completes their repairs before the Time-out Clock expires, the ALLIANCE CAPTAIN is encouraged to inform the Head Referee that they are ready to play and remit any time remaining in the TIME-OUT. If ALLIANCES are ready before the 6-minute window, the next match will start. There are no cascading time-outs. An opposing ALLIANCE may not offer their unused TIME-OUT to their opponent.
- <T21> If during a TIME-OUT an ALLIANCE CAPTAIN determines that they need to call up a BACKUP TEAM, they must submit their BACKUP TEAM coupon to the Head Referee while there is still at least two minutes remaining on the Time-out Clock. After that point, they will not be allowed to utilize the BACKUP TEAM. Alternatively, an ALLIANCE CAPTAIN may choose to call up a BACKUP TEAM without using their TIME-OUT by informing the Head Referee directly within two minutes of the Head Referee issuing the Field Reset Signal preceding their match.
- <T22> In the case where the ALLIANCE CAPTAIN's team is replaced with the BACKUP TEAM, the ALLIANCE CAPTAIN is allowed in the Team Zone as a thirteenth ALLIANCE member so they can serve in an advisory role to their ALLIANCE.

9.6.6 Special Equipment Rules

<T23> The only equipment that may be brought on to the field is the OPERATOR CONSOLE, reasonable decorative items, and special clothing and/or equipment required due to a disability. Other items, particularly those intended to provide a competitive advantage for the HUMAN PLAYER, are prohibited.

Devices used solely for the purpose of planning or tracking strategy of game play are allowed inside the ALLIANCE ZONE, if they meet ALL of the following conditions:

- Do not connect or attach to the OPERATOR CONSOLE
- Do not connect or attach to the FIELD or ARENA
- Do not connect or attach to another alliance member

- Do not communicate with anything or anyone outside of the ALLIANCE ZONE (for example wireless communications must be disabled).
- Do not in any way affect the outcome of a MATCH, other than by allowing team members to plan or track strategy for the purposes of communication of that strategy to other alliance members.



THE KIT OF PARTS

TABLE OF CONTENTS

10	THE KIT OF PARTS	2
10.1	THE KIT OF PARTS	2
10.1.1	Kit Evolution.....	2
10.1.2	Kit of Parts Contents.....	2
10.1.3	Replacement Parts Requests	3
10.1.4	Innovation First Kit of Parts:.....	3
10.1.5	Obtaining Additional or Spare Parts:	3
10.1.6	<i>FIRST</i> Loan policy for Control System Components:	4

10 THE KIT OF PARTS

10.1 THE KIT OF PARTS

FIRST provides a Kit of Parts (KOP) to each FRC team. Only the exact parts provided in the KOP (or their exact replacement) are considered Kit Parts. Some Kit Parts may legally be used in additional quantities as described in Section 8.3.4.1 of the Manual. Additional quantities of these parts are considered to be “Additional Parts” and not “Kit Parts”.

10.1.1 Kit Evolution

Some of the exciting and important additions found in the 2007 Kit Items include the following items:

- All event-registered teams were invited to apply for National Instruments DAQ modules and receive their LabVIEW software before Kickoff.
- One C-programming tutorial account with Machine Science
- Two BaneBots planetary, 12:1 transmissions.
- One 36mm BaneBots gearmotor
- One BaneBots RS545 motor
- One vacuum kit (including 4mm pneumatic tubing, suction cup, and vacuum generator)
- Four AndyMark, Inc designed wheels which include integral molded hub adapters
- Two target light kits enabling teams to practice working with dual light targets
- One DualVee linear track system including four wheels, two concentric bushings, two eccentric bushings, and two pieces of track
- One Allen-Bradley terminal block assembly and two pieces of DIN rail to replace the power distribution block and ground stud
- Assorted Tyco electrical terminals
- One modification kit for the battery chargers facilitating the use of the Anderson Power Products connectors to plug into the batteries

10.1.2 Kit of Parts Contents

The *FIRST* 2007 Kit of Parts is provided in multiple containers. They consist of the following packages:

- 1) 1 – *FIRST* large red plastic tote for pickup at Kickoff
- 2) 1 – *FIRST* large blue plastic tote for pickup at Kickoff
- 3) 1 – Innovation First, Inc. KitBot box for pickup at Kickoff
- 4) 1 – Innovation First, Inc. Electronics Kit for pickup at Kickoff
- 5) 1 – SMC Pneumatics bag for pickup at Kickoff
- 6) 1 – Allegro Microsystems Gear Tooth Sensor Envelope for pickup at Kickoff
- 7) 1 – Analog Devices Sensor Envelope to be mailed after Kickoff

Use the 2007 Kit of Parts Checklist provided at www.usfirst.org/frc/2007/manual to inventory your Kit of Parts. The inventory must be completed within 48 hours of receiving the kit in order to determine that all items are present. **Any irregularities must be reported by 11:59 pm (EST) on Wednesday, January 10, 2007 per instructions in Section 10.1.3.**

The first column on the checklist should be marked when the item and quantities are correct. All bags are labeled. Photos are included in the checklist in case you are not sure what a particular part should look like.

10.1.3 Replacement Parts Requests

After receiving your Kit of Parts, you will use a similar system as last year to submit a "Replacement Parts Request" within a short period of time after the kickoff. Any parts requested will be sent to teams via this online request system only. The Replacement Parts Request link will be posted on the Team Information Management System (TIMS) after the Kickoff event.

The steps required to submit a Replacement Parts Request (after the kickoff) are as follows:

- Log into TIMS with your Logon ID and Password
- Click on the "Submit a Replacement Parts Request" link on right side of the Team Summary page
- Follow TIMS instructions to complete a Replacement Parts Request

****IMPORTANT****

Please remember there is a **time limited, one-time only** chance for submitting your Replacement Parts Request. Please be very careful to make sure your request is both accurate and complete prior to pressing the "Submit Request" button. Once the request is submitted there can be no changes to it. Please note that the system will not allow teams to request a quantity of parts higher than the number originally sent with the kit. **This system is also not to be used to order additional and/or purchased parts.**

Replacement Parts Requests will be processed daily and items will be shipped to teams during the next open shipping window. **Please remember that all requests must be placed by 11:59 pm (Eastern Time) on Wednesday, January 10, 2007.**

10.1.4 Innovation First Kit of Parts:

To submit a Replacement Parts Request for your IFI supplied kit items or for product support (to obtain a Return Merchandise Authorization Number (RMA#) prior to the return of warranted IFI parts) please contact Innovation First, Inc. at 903-453-0802. Do **not** contact *FIRST* for replacements or repairs of these items.

10.1.5 Obtaining Additional or Spare Parts:

We will have a listing of the LIMITED set of parts that will be available at events posted on the *FIRST* web site no later than January 12, 2007. If your robot is using parts not included on this list, and there is a reasonable possibility the part could be damaged or broken during competition, it is **STRONGLY RECOMMENDED** that you obtain and bring the appropriate SPARE PARTS to events.

Please use the table provided in the *2007 FIRST Guidelines, Tips, and Good Practices* document to order additional parts to those provided in the kit.

Innovation First, Inc. is also hosting the *FIRST* Store on behalf of *FIRST* on the Innovation First website. Its purpose is to assist teams with the ability to procure excess Kit of Parts items from *FIRST*. Only *FIRST* teams will be authorized to purchase the listed parts. *FIRST* will establish pricing for all parts, which will be inclusive of handling charges, but exclusive of shipping charges.

Additional parts and spare Innovation First parts are available and may be purchased by visiting the *IFI Store* at <http://www.ifrobotics.com/> The Innovation First, Inc. contact for *FIRST* Store matters is Tom Watson at 903-453-0800, extension 204.

10.1.6 *FIRST* Loan policy for Control System Components:

Teams are responsible for all Innovation First products required at events. If at any event a team needs to borrow any part of a Control System, the team must provide a Credit Card number to ensure proper return of the items immediately upon completion of the event.

If the part is not returned at the end of the event, *FIRST* retains the right to bill the provided credit card number for the borrowed items.

All “loan” items will be available on a first-come, first-served basis.